

6. DIMENSIONING METRIC SCREW ASSEMBLIES

VDI guideline 2230, published in 2003, provides fundamental information on dimensioning, in particular of high-strength screw assemblies in engineering.

The calculation of a screw assembly starts from the operating force F_B that works on the joint from the outside. This operating force and the elastic deformations of the components that it causes bring about an axial operating force $F_{A'}$, a shear force F_Q , a bending moment M_b and where applicable a torque M_T at the individual screw position.

When the necessary screw dimension is calculated mathematically, it must be taken into account, starting from the known load ratios, that a loss of preload force can occur through setting processes and temperature changes.

It must also be taken into account that, depending on the chosen assembly method and on the frictional conditions, the assembly preload force F_M can disperse in more or less wide limits.

An approximate dimensioning is often sufficient for an initial selection of the suitable screw dimension. Depending on the application, further criteria are then to be checked in accordance with VDI 2230.

6.1 Approximate calculation of the dimension or the strength classes of screws (in accordance with VDI 2230)

On the basis of the above-mentioned findings, the pre-selection of the screw is carried out in the first step in accordance with the following table.

1	2	3	4
Force in N	Nominal diameter in mm		
	Strength class		
	12.9	10.9	8.8
250			
400			
630			
1.000	M3	M3	M3
1.600	M3	M3	M3

1	2	3	4
Force in N	Nominal diameter in mm		
	Strength class		
	12.9	10.9	8.8
2.500	M3	M3	M4
4.000	M4	M4	M5
6.300	M4	M5	M6
10.000	M5	M6	M8
16.000	M6	M8	M10
25.000	M8	M10	M12
40.000	M10	M12	M14
63.000	M12	M14	M16
100.000	M16	M18	M20
160.000	M20	M22	M24
250.000	M24	M27	M30
400.000	M30	M33	M36
630.000	M36	M39	

Tab. 1

A From column 1 choose the next higher force to the one that acts on the joint. If the combined load (lengthwise and shear forces $F_{Amax} < F_{Qmax} / \mu_{Tmin}$) apply, only F_{Qmax} is to be used.

B The necessary minimum preload force F_{Mmin} is found by proceeding as follows from this figure:

B1 If the design has to use F_{Qmax} : four steps for static or dynamic shear force

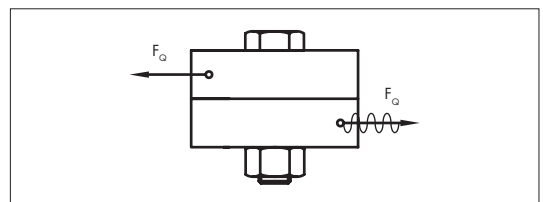

B2 If the design has to use F_{Amax} : 2 steps for dynamic and eccentric axial force

or

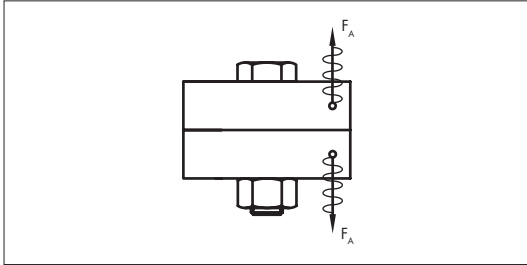

or

1 step for dynamic and concentric or static and eccentric axial force

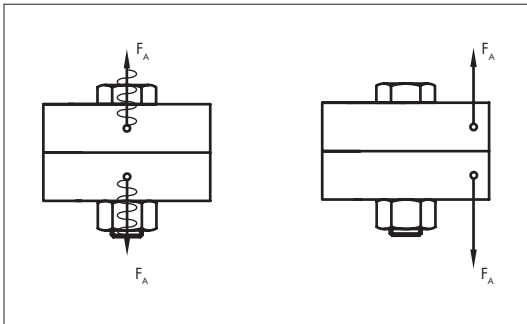

or

0 steps for static and concentric axial force

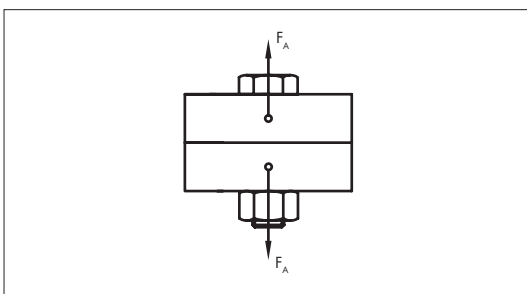

C The required maximum preload force F_{Mmax} is found by proceeding from force F_{Mmin} with:
2 steps for tightening the screw with a simple screwdriver which is set for a tightening torque

or

1 step for tightening with a torque wrench or precision screwdriver, which is set by means of the dynamic torque measurement or elongation of the screw

or

0 steps for tightening by angle control in the plastic range or by computerised yield point control

D Next to the number that is found, the required screw dimension in mm for the appropriate strength class for the screw is found in columns 2 to 4.

Example:

A joint is subjected dynamically and eccentrically to an axial force of 9000 N (F_A).

The strength class was stipulated previously as strength class 10.9.

The installation is carried out using a torque wrench.

A 10.000 N is the next higher force in column 1 for the force F_A

B 2 additional steps because of eccentric and dynamic axial force

Reading: 25,000 N ($= F_{Mmin}$)

C 1 additional step because of the tightening method using a torque wrench

Reading: 40,000 N ($= F_{Mmax}$)

D The screw size M12 is now read in column 3 for strength class 10.9.

6.2 Choosing the tightening method and the mode of procedure

Tightening factor α_A (taking the tightening uncertainty into account)

All tightening methods are more or less accurate. This is caused by:

- the large range of distribution of the friction that actually occurs during installation (friction figures can only be estimated roughly for the calculation)
- differences in the manipulation with the torque wrench (e.g. fast or slow tightening of the screw)

Depending on whether the influences referred to above can be controlled, the tightening factor α_A has to be selected.

A calculation is therefore made taking account of the tightening and setting method, as well as the coefficients of friction classes in accordance with the following table.

Reference values for the tightening factor α_A

Tightening factor α_A	Distribution	Tightening method	Setting method	Notes
1.05 to 1.2	$\pm 2\%$ to $\pm 10\%$	Elongation-controlled tightening with ultrasound	Sound transmission time	<ul style="list-style-type: none"> Calibration values required With $l_k/d < 2$ progressive fault increase to be noted Smaller fault with direct mechanical coupling, greater fault with indirect coupling
1.1 to 1.5	$\pm 5\%$ to $\pm 20\%$	Mechanical length measuring	Setting by means of elongation measurement	<ul style="list-style-type: none"> The exact determination of the screw's axial elastic flexibility is necessary. The distribution depends essentially on the accuracy of the measuring method. With $l_k/d < 2$ progressive fault increase to be noted
1.2 to 1.4	$\pm 9\%$ to $\pm 17\%$	Yield strength controlled tightening, power-operated or manual	Input of the relative torque – angle of rotation coefficients	The preload force distribution is determined basically through the distribution of the yield point in the installed screw batch. The screws are dimensioned here for F_{Mmin} . A construction of the screws for F_{Mmax} with the tightening factor α_A is therefore not applicable for these tightening methods.
1.2 to 1.4	$\pm 9\%$ to $\pm 17\%$	Rotation angle controlled tightening, power-operated or manual	Experimental determination of preliminary torque and angle of rotation (stages)	
1.2 to 1.6	$\pm 9\%$ to $\pm 23\%$	Hydraulic tightening	Setting by means of length or pressure measuring	<ul style="list-style-type: none"> Lower values for long screws ($l_k/d \geq 5$) Higher values for short screws ($l_k/d \leq 2$)
1.4 to 1.6	$\pm 17\%$ to $\pm 23\%$	Torque controlled tightening with torque wrench, torque signalling wrench or mechanical screw driver with dynamic torque measuring	Experimental determination of target torques at the original screw part, e.g. by means of elongation measurements of the screw	<div style="display: flex; justify-content: space-between;"> <div style="width: 45%;"> <p>Lower values: large number of setting or control tests necessary (e.g. 20). Low distribution of the given torque (e.g. $\pm 5\%$) necessary.</p> </div> <div style="width: 45%;"> <p>Lower values for: low angle of rotation, i.e. relatively stiff connections relatively low hardness of the counter-surface</p> </div> </div>
1.6 to 2.0 (coefficient of friction class B)	$\pm 23\%$ to $\pm 33\%$	Torque controlled tightening with torque wrench, torque signalling wrench or mechanical screw driver with dynamic torque measuring	Determining the target torques by estimating the coefficient of friction (surface- and lubrication ratios)	<div style="display: flex; justify-content: space-between;"> <div style="width: 45%;"> <p>Lower values for: measuring torque wrench on even tightening and for precision torque wrenches Higher values for: signalling or collapsing torque wrench</p> </div> <div style="width: 45%;"> <p>Counter-surfaces that do not tend to "seize", e.g. phosphated or with sufficient lubrication. Higher values for: large angle of rotation, i.e. relatively resilient connections and fine threads Very hard counter-surfaces in combination with rough surface.</p> </div> </div>
1.7 to 2.5 (coefficient of friction class A)	$\pm 26\%$ to $\pm 43\%$			<div style="display: flex; justify-content: space-between;"> <div style="width: 45%;"> <p>Lower values for: large number of setting tests (retightening torque) on the horizontal branch of the screw driver characteristics impulse transmission without play</p> </div> </div>
2.5 to 4	$\pm 43\%$ to $\pm 60\%$	Tightening with impact or impulse screw driver	Setting the screws by means of the retightening torque, which comprises the target tightening torque (for the estimated coefficient of friction) and a supplement	<div style="display: flex; justify-content: space-between;"> <div style="width: 45%;"> <p>Lower values for: large number of setting tests (retightening torque) on the horizontal branch of the screw driver characteristics impulse transmission without play</p> </div> </div>

Tab. 2

A different coefficient of friction “ μ ” has to be selected, depending on the surface and lubrication condition of the screws or nut coat. With the great number of surface and lubrication conditions it is often difficult to ascertain the correct coefficient of friction. If the coefficient of friction is not known exactly, the lowest probable coefficient of friction is to be reckoned with so that the screw is not overloaded.

6.3 Allocation of friction coefficients with reference values to different materials/surfaces and lubrication conditions in screw assemblies (in accordance with VDI 2230)

Coefficient of friction class	Range for μ_e and μ_k	Selection of typical examples for	
		Material/surface	Lubricants
A	0.04 to 0.10	Bright metal Black annealed Phosphate Galv. coatings such as Zn, Zn/Fe, Zn/Ni, zinc flake coatings	Solid lubricants such as MoS ₂ , graphite, PTFE, PA, PE, PI in solid film lubricants, as top coats or in pastes; liquefied wax; wax dispersions
B	0.08 to 0.16	Bright metal Black annealed Phosphate Galv. coatings such as Zn, Zn/Fe, Zn/Ni, zinc flake coatings, Al and Mg alloys	Solid lubricants such as MoS ₂ , graphite, PTFE, PA, PE, PI in solid film lubricants, as top coats or in pastes; liquefied wax; wax dispersions; greases, oils, delivery condition
		Hot dip galvanised	MoS ₂ ; graphite; wax dispersions
		Organic coating	With integrated solid lubricant or wax dispersion
		Austenitic steel	Solid lubricants, waxes, pastes
C	0.14 to 0.24	Austenitic steel	Wax dispersions, pastes
		Bright metal, Phosphate	Delivery condition (lightly oiled)
		Galv. coatings such as Zn, Zn/Fe, Zn/Ni, zinc flake coatings, adhesive	None
D	0.20 to 0.35	Austenitic steel	Oil
		Galv. coatings such as Zn, Zn/Fe, hot-dip galvanised	None
E	≥ 0.30	Galv. coatings such as Zn/Fe, Zn/Ni, austenitic steel, Al, Mg alloys	None

Tab. 3

Coefficient of friction class B should be aimed for, so that the highest possible preload force with simultaneous low distribution can be applied. (The table applies to room temperature.)

6.4 Assembly preload forces F_{MTob} and tightening torques M_A with 90% utilisation of the screw yield strength R_{e1} or 0.2% offset yield point $R_{p0.2}$ for set screws with metric standard thread in accordance with DIN ISO 262; head sizes of hexagon head screws in accordance with DIN EN ISO 4014 to 4018, screws with external hexalobular drive in accordance with DIN 34800 or socket cap screws in accordance with DIN EN ISO 4762 and “medium” bore in accordance with DIN EN 20 273 (in accordance with VDI 2230)

Standard thread

Size	Strength class	Assembly preload forces F_{MTab} in kN for $\mu_G =$								Tightening torques M_A in Nm for $\mu_k = \mu_G =$							
		0.08	0.10	0.12	0.14	0.16	0.20	0.24	0.08	0.10	0.12	0.14	0.16	0.20	0.24		
		M4	8.8 10.9 12.9	4.6 6.8 8.0	4.5 6.7 7.8	4.4 6.5 7.6	4.3 6.3 7.4	4.2 6.1 7.1	3.9 5.7 6.7	3.7 5.4 6.3	2.3 3.3 3.9	2.6 3.9 4.5	3.0 4.6 5.1	3.3 4.8 5.6	3.6 5.3 6.2	4.1 6.0 7.0	4.5 6.6 7.8
M5	8.8 10.9 12.9	7.6 11.1 13.0	7.4 10.8 12.7	7.2 10.6 12.4	7.0 10.3 12.0	6.8 10.0 11.7	6.4 9.4 11.0	6.0 8.8 10.3	4.4 6.5 7.6	5.2 7.6 8.9	5.9 8.6 10.0	6.5 9.5 11.2	7.1 10.4 12.2	8.1 11.9 14.0	9.0 13.2 15.5		
M6	8.8 10.9 12.9	10.7 15.7 18.4	10.4 15.3 17.9	10.2 14.9 17.5	9.9 14.5 17.0	9.6 14.1 16.5	9.0 13.2 15.5	8.4 12.4 14.5	7.7 11.3 13.2	9.0 13.2 15.4	10.1 14.9 17.4	11.3 16.5 19.3	12.3 18.0 21.1	14.1 20.7 24.2	15.6 22.9 26.8		
M7	8.8 10.9 12.9	15.5 22.7 26.6	15.1 22.5 26.0	14.8 21.7 25.4	14.4 21.1 24.7	14.0 20.5 24.0	13.1 19.3 22.6	12.3 18.1 21.2	12.6 18.5 21.6	14.8 21.7 25.4	16.8 24.7 28.9	18.7 27.5 32.2	20.5 30.1 35.2	23.6 34.7 40.6	26.2 38.5 45.1		
M8	8.8 10.9 12.9	19.5 28.7 33.6	19.1 28.0 32.8	18.6 27.3 32.0	18.1 26.6 31.1	17.6 25.8 30.2	16.5 24.3 28.4	15.5 22.7 26.6	18.5 27.2 31.8	21.6 31.8 37.2	24.6 36.1 42.2	27.3 40.1 46.9	29.8 43.8 51.2	34.3 50.3 58.9	38.0 55.8 65.3		
M10	8.8 10.9 12.9	31.0 45.6 53.3	30.3 44.5 52.1	29.6 43.4 50.8	28.8 42.2 49.4	27.9 41.0 48.0	26.3 38.6 45.2	24.7 36.2 42.4	36 53 62	43 63 73	48 71 83	54 79 93	59 87 101	68 100 116	75 110 129		
M12	8.8 10.9 12.9	45.2 66.3 77.6	44.1 64.8 75.9	43.0 63.2 74.0	41.9 61.5 72.0	40.7 59.8 70.0	38.3 56.3 65.8	35.9 52.8 61.8	63 92 108	73 108 126	84 123 144	93 137 160	102 149 175	117 172 201	130 191 223		
M14	8.8 10.9 12.9	62.0 91.0 106.5	60.6 88.9 104.1	59.1 86.7 101.5	57.5 84.4 98.8	55.9 82.1 96.0	52.6 77.2 90.4	49.3 72.5 84.8	100 146 171	117 172 201	133 195 229	148 218 255	162 238 279	187 274 321	207 304 356		
M16	8.8 10.9 12.9	84.7 124.4 145.5	82.9 121.7 142.4	80.9 118.8 139.0	78.8 115.7 135.4	76.6 112.6 131.7	72.2 106.1 124.1	67.8 99.6 116.6	153 224 262	180 264 309	206 302 354	230 338 395	252 370 433	291 428 501	325 477 558		
M18	8.8 10.9 12.9	107 152 178	104 149 174	102 145 170	99 141 165	96 137 160	91 129 151	85 121 142	220 314 367	259 369 432	295 421 492	329 469 549	360 513 601	415 592 692	462 657 769		
M20	8.8 10.9 12.9	136 194 227	134 190 223	130 186 217	127 181 212	123 176 206	116 166 194	109 156 182	308 438 513	363 517 605	415 592 692	464 661 773	509 725 848	588 838 980	655 933 1,092		
M22	8.8 10.9 12.9	170 242 283	166 237 277	162 231 271	158 225 264	154 219 257	145 207 242	137 194 228	417 595 696	495 704 824	567 807 945	634 904 1,057	697 993 1,162	808 1,151 1,347	901 1,284 1,502		
M24	8.8 10.9 12.9	196 280 327	192 274 320	188 267 313	183 260 305	178 253 296	168 239 279	157 224 262	529 754 882	625 890 1,041	714 1,017 1,190	798 1,136 1,329	875 1,246 1,458	1,011 1,440 1,685	1,126 1,604 1,877		
M27	8.8 10.9 12.9	257 367 429	252 359 420	246 351 410	240 342 400	234 333 389	220 314 367	207 295 345	772 1,100 1,287	915 1,304 1,526	1,050 1,496 1,750	1,176 1,674 1,959	1,292 1,840 2,153	1,498 2,134 2,497	1,672 2,381 2,787		
M30	8.8 10.9 12.9	313 446 522	307 437 511	300 427 499	292 416 487	284 405 474	268 382 447	252 359 420	1,053 1,500 1,755	1,246 1,775 2,077	1,428 2,033 2,380	1,597 2,274 2,662	1,754 2,498 2,923	2,931 4,293 5,135	2,265 3,226 3,775		
M33	8.8 10.9 12.9	389 554 649	381 543 635	373 531 621	363 517 605	354 504 589	334 475 556	314 447 523	1,415 2,015 2,358	1,679 2,322 2,799	1,928 2,747 3,214	2,161 3,078 3,601	2,377 3,385 3,961	2,759 3,930 4,598	3,081 4,388 5,135		
M36	8.8 10.9 12.9	458 652 763	448 638 747	438 623 729	427 608 711	415 591 692	392 558 653	368 524 614	1,825 2,600 3,042	2,164 3,082 3,607	2,482 3,535 4,136	2,778 3,957 4,631	3,054 4,349 5,089	3,541 5,043 5,902	3,951 5,627 6,585		
M39	8.8 10.9 12.9	548 781 914	537 765 895	525 748 875	512 729 853	498 710 831	470 670 784	443 630 738	2,348 3,345 3,914	2,791 3,975 4,652	3,208 4,569 5,346	3,597 5,123 5,994	3,958 5,637 6,596	4,598 6,549 7,664	5,137 7,317 8,562		

Tab. 5

Assembly preload forces F_{MTab} and tightening torques M_A with 90% utilisation of the screw yield strength R_{el} or 0.2% offset yield point $R_{p0.2}$ for **set screws with metric fine thread** in accordance with DIN ISO 262; head sizes of hexagon head screws in accordance with DIN EN ISO 4014 to 4018, screws with external hexalobular drive in accordance with DIN 34800 or socket cap screws in accordance with DIN EN ISO 4762 and "medium" bore in accordance with DIN EN 20 273 (in accordance with VDI 2230)

Fine thread

Size	Strength class	Assembly preload forces F_{MTab} in kN for $\mu_G =$							Tightening torques M_A in Nm for $\mu_K = \mu_G =$						
		0.08	0.10	0.12	0.14	0.16	0.20	0.24	0.08	0.10	0.12	0.14	0.16	0.20	0.24
M8 x 1	8.8	21.2	20.7	20.2	19.7	19.2	18.1	17.0	19.3	22.8	26.1	29.2	32.0	37.0	41.2
	10.9	31.1	30.4	29.7	28.9	28.1	26.5	24.9	28.4	33.5	38.3	42.8	47.0	54.3	60.5
	12.9	36.4	35.6	34.7	33.9	32.9	31.0	29.1	33.2	39.2	44.9	50.1	55.0	63.6	70.8
M9 x 1	8.8	27.7	27.2	26.5	25.9	25.2	23.7	22.3	28.0	33.2	38.1	42.6	46.9	54.4	60.7
	10.9	40.7	39.9	39.0	38.0	37.0	34.9	32.8	41.1	48.8	55.9	62.6	68.8	79.8	89.1
	12.9	47.7	46.7	45.6	44.4	43.3	40.8	38.4	48.1	57.0	65.4	73.3	80.6	93.4	104.3
M10 x 1	8.8	35.2	34.5	33.7	32.9	32.0	30.2	28.4	39	46	53	60	66	76	85
	10.9	51.7	50.6	49.5	48.3	47.0	44.4	41.7	57	68	78	88	97	112	125
	12.9	60.4	59.2	57.9	56.5	55.0	51.9	48.8	67	80	91	103	113	131	147
M10 x 1,25	8.8	33.1	32.4	31.6	30.8	29.9	28.2	26.5	38	44	51	57	62	72	80
	10.9	48.6	47.5	46.4	45.2	44.0	41.4	38.9	55	65	75	83	92	106	118
	12.9	56.8	55.6	54.3	52.9	51.4	48.5	45.5	65	76	87	98	107	124	138
M12 x 1,25	8.8	50.1	49.1	48.0	46.8	45.6	43.0	40.4	66	79	90	101	111	129	145
	10.9	73.6	72.1	70.5	68.7	66.9	63.2	59.4	97	116	133	149	164	190	212
	12.9	86.2	84.4	82.5	80.4	78.3	73.9	69.5	114	135	155	174	192	222	249
M12 x 1,5	8.8	47.6	46.6	45.5	44.3	43.1	40.6	38.2	64	76	87	97	107	123	137
	10.9	70.0	68.5	66.8	65.1	63.3	59.7	56.0	95	112	128	143	157	181	202
	12.9	81.9	80.1	78.2	76.2	74.1	69.8	65.6	111	131	150	167	183	212	236
M14 x 1,5	8.8	67.8	66.4	64.8	63.2	61.5	58.1	45.6	104	124	142	159	175	203	227
	10.9	99.5	97.5	95.2	92.9	90.4	85.3	80.2	153	182	209	234	257	299	333
	12.9	116.5	114.1	111.4	108.7	105.8	99.8	93.9	179	213	244	274	301	349	390
M16 x 1,5	8.8	91.4	89.6	87.6	85.5	83.2	78.6	74.0	159	189	218	244	269	314	351
	10.9	134.2	131.6	128.7	125.5	122.3	115.5	108.7	233	278	320	359	396	461	515
	12.9	157.1	154.0	150.6	146.9	143.1	135.1	127.2	273	325	374	420	463	539	603
M18 x 1,5	8.8	122	120	117	115	112	105	99	237	283	327	368	406	473	530
	10.9	174	171	167	163	159	150	141	337	403	465	523	578	674	755
	12.9	204	200	196	191	186	176	166	394	472	544	613	676	789	884
M18 x 2	8.8	114	112	109	107	104	98	92	229	271	311	348	383	444	495
	10.9	163	160	156	152	148	139	131	326	386	443	496	545	632	706
	12.9	191	187	182	178	173	163	153	381	452	519	581	638	740	826
M20 x 1,5	8.8	154	151	148	144	141	133	125	327	392	454	511	565	660	741
	10.9	219	215	211	206	200	190	179	466	558	646	728	804	940	1,055
	12.9	257	252	246	241	234	222	209	545	653	756	852	941	1,100	1,234
M22 x 1,5	8.8	189	186	182	178	173	164	154	440	529	613	692	765	896	1,006
	10.9	269	264	259	253	247	233	220	627	754	873	985	1,090	1,276	1,433
	12.9	315	309	303	296	289	273	257	734	882	1,022	1,153	1,275	1,493	1,677
M24 x 1,5	8.8	228	224	219	214	209	198	187	570	686	796	899	995	1,166	1,311
	10.9	325	319	312	305	298	282	266	811	977	1,133	1,280	1,417	1,661	1,867
	12.9	380	373	366	357	347	330	311	949	1,143	1,326	1,498	1,658	1,943	2,185
M24 x 2	8.8	217	213	209	204	198	187	177	557	666	769	865	955	1,114	1,248
	10.9	310	304	297	290	282	267	251	793	949	1,095	1,232	1,360	1,586	1,777
	12.9	362	355	348	339	331	312	294	928	1,110	1,282	1,442	1,591	1,856	2,080
M27 x 1,5	8.8	293	288	282	276	269	255	240	822	992	1,153	1,304	1,445	1,697	1,910
	10.9	418	410	402	393	383	363	342	1,171	1,413	1,643	1,858	2,059	2,417	2,720
	12.9	489	480	470	460	448	425	401	1,370	1,654	1,922	2,174	2,409	2,828	3,183

Size	Strength class	Assembly preload forces $F_{M_{Tab}}$ in kN for $\mu_g =$							Tightening torques M_A in Nm for $\mu_k = \mu_g =$						
		0.08	0.10	0.12	0.14	0.16	0.20	0.24	0.08	0.10	0.12	0.14	0.16	0.20	0.24
M27 x 2	8.8	281	276	270	264	257	243	229	806	967	1,119	1,262	1,394	1,630	1,829
	10.9	400	393	384	375	366	346	326	1,149	1,378	1,594	1,797	1,986	2,322	2,605
	12.9	468	460	450	439	428	405	382	1,344	1,612	1,866	2,103	2,324	2,717	3,049
M30 x 2	8.8	353	347	339	331	323	306	288	1,116	1,343	1,556	1,756	1,943	2,276	2,557
	10.9	503	494	483	472	460	436	411	1,590	1,912	2,216	2,502	2,767	3,241	3,641
	12.9	588	578	565	552	539	510	481	1,861	2,238	2,594	2,927	3,238	3,793	4,261
M33 x 2	8.8	433	425	416	407	397	376	354	1,489	1,794	2,082	2,352	2,605	3,054	3,435
	10.9	617	606	593	580	565	535	505	2,120	2,555	2,965	3,350	3,710	4,350	4,892
	12.9	722	709	694	678	662	626	591	2,481	2,989	3,470	3,921	4,341	5,090	5,725
M36 x 2	8.8	521	512	502	490	478	453	427	1,943	2,345	2,725	3,082	3,415	4,010	4,513
	10.9	742	729	714	698	681	645	609	2,767	3,340	3,882	4,390	4,864	5,711	6,428
	12.9	869	853	836	817	797	755	712	3,238	3,908	4,542	5,137	5,692	6,683	7,522
M39 x 2	8.8	618	607	595	581	567	537	507	2,483	3,002	3,493	3,953	4,383	5,151	5,801
	10.9	880	864	847	828	808	765	722	3,537	4,276	4,974	5,631	6,243	7,336	8,263
	12.9	1,030	1,011	991	969	945	896	845	4,139	5,003	5,821	6,589	7,306	8,585	9,669

Tab. 6

6.5 Tightening torque and preload force of

- Safety screws with nuts
- Flange screws with nuts

With 90% utilisation of the screws' yield strength R_{el} or 0.2% offset yield point $R_{p0.2}$ (according to manufacturer's data)

	Counter material	Preload forces F_{Vmax} (N)							Tightening torque M_A (Nm)						
		M5	M6	M8	M10	M12	M14	M16	M5	M6	M8	M10	M12	M14	M16
Locking screws strength class 100 and nuts strength class 10	Steel $R_m < 800$ MPa	9,000	12,600	23,200	37,000	54,000	74,000	102,000	11	19	42	85	130	230	330
	Steel $R_m = 800-1,100$ MPa	9,000	12,600	23,200	37,000	54,000	74,000	102,000	10	18	37	80	120	215	310
	Gray cast iron	9,000	12,600	23,200	37,000	54,000	74,000	102,000	9	16	35	75	115	200	300

Reference values

6.6 Reference values for tightening torques for austenite screws in accordance with DIN EN ISO 3506

The following table shows the tightening torque required for an individual case in dependence on the nominal diameter, the coefficient of friction and the strength class (SC) as a reference value.

Coefficient of friction μ_{ges} 0.10

	Preload forces $F_{Vmax.}$ [KN]			Tightening torque M_A [Nm]		
	FK 50	FK 70	FK 80	FK 50	FK 70	FK 80
M3	0.90	1.00	1.20	0.85	1.00	1.30
M4	1.08	2.97	3.96	0.80	1.70	2.30
M5	2.26	4.85	6.47	1.60	3.40	4.60
M6	3.2	6.85	9.13	2.80	5.90	8.00
M8	5.86	12.6	16.7	6.80	14.5	19.3
M10	9.32	20.0	26.6	13.7	30.0	39.4
M12	13.6	29.1	38.8	23.6	50.0	67.0
M14	18.7	40.0	53.3	37.1	79.0	106.0
M16	25.7	55.0	73.3	56.0	121.0	161.0
M18	32.2	69.0	92.0	81.0	174.0	232.0
M20	41.3	88.6	118.1	114.0	224.0	325.0
M22	50.0	107.0	143.0	148.0	318.0	424.0
M24	58.0	142.0	165.0	187.0	400.0	534.0
M27	75.0			275.0		
M30	91.0			374.0		
M33	114.0			506.0		
M36	135.0			651.0		
M39	162.0			842.0		

Coefficient of friction μ_{ges} 0.20

	Preload forces $F_{Vmax.}$ [KN]			Tightening torque M_A [Nm]		
	FK 50	FK 70	FK 80	FK 50	FK 70	FK 80
M3	0.60	0.65	0.95	1.00	1.10	1.60
M4	1.12	2.40	3.20	1.30	2.60	3.50
M5	1.83	3.93	5.24	2.40	5.10	6.90
M6	2.59	5.54	7.39	4.10	8.80	11.8
M8	4.75	10.2	13.6	10.1	21.4	28.7
M10	7.58	16.2	21.7	20.3	44.0	58.0
M12	11.1	23.7	31.6	34.8	74.0	100.0
M14	15.2	32.6	43.4	56.0	119.0	159.0
M16	20.9	44.9	59.8	86.0	183.0	245.0
M18	26.2	56.2	74.9	122.0	260.0	346.0
M20	33.8	72.4	96.5	173.0	370.0	494.0
M22	41.0	88.0	118.0	227.0	488.0	650.0
M24	47.0	101.0	135.0	284.0	608.0	810.0
M27	61.0			421.0		
M30	75.0			571.0		
M33	94.0			779.0		
M36	110.0			998.0		
M39	133.0			1.300		

Coefficient of friction μ_{ges} 0.30

	Preload forces $F_{Vmax.}$ [KN]			Tightening torque M_A [Nm]		
	FK 50	FK 70	FK 80	FK 50	FK 70	FK 80
M3	0.40	0.45	0.70	1.25	1.35	1.85
M4	0.90	1.94	2.59	1.50	3.00	4.10
M5	1.49	3.19	4.25	2.80	6.10	8.00
M6	2.09	4.49	5.98	4.80	10.4	13.9
M8	3.85	8.85	11.0	11.9	25.5	33.9
M10	6.14	13.1	17.5	24.0	51.0	69.0
M12	9.00	19.2	25.6	41.0	88.0	117.0
M14	12.3	26.4	35.2	66.0	141.0	188.0
M16	17.0	36.4	48.6	102.0	218.0	291.0
M18	21.1	45.5	60.7	144.0	308.0	411.0
M20	27.4	58.7	78.3	205.0	439.0	586.0
M22	34.0	72.0	96.0	272.0	582.0	776.0
M24	39.0	83.0	110.0	338.0	724.0	966.0
M27	50.0			503.0		
M30	61.0			680.0		
M33	76.0			929.0		
M36	89.0			1.189		
M39	108.0			1.553		

Tab. 8

6.7 How to use the tables for preload forces and tightening torques!

The procedure is as follows:

A) Determining the total coefficient of friction

$\mu_{ges.}$:

Different coefficients of friction “ μ ” have to be reckoned with, depending on the surface or lubrication condition of the screws or nuts. Table 3 in chapter 6 is used to make the selection.

Example:

Selecting the screw and nut with surface condition zinc galvanised transparent passivation, without lubricant:

$\mu_{ges} = 0.14$

(Note: the lowest probable coefficient of friction is to be reckoned with for the dimensioning of the screw so that it is not overloaded)

B) Tightening torque M_A max.

The maximum tightening torque is found with 90% utilisation of the 0.2% offset yield point ($R_{p0.2}$) or of the yield point (R_{el}).

Example:

Hexagon head screw DIN 933, M12 x 50, strength class 8.8, galvanised, blue passivation:

In Table 5 in chapter 6 look in the column for $\mu_G = 0.14$ for the line for M12 with strength class 8.8.

Now read off the desired value

$M_{Amax} = 93 \text{ Nm}$

from the section “Tightening torque MA [Nm]”.

C) Tightening factor α_A (taking the tightening uncertainty into account)

All tightening methods are more or less accurate. This is caused by:

- The large range of distribution of the friction that actually occurs during installation
(if friction figures can only be estimated roughly for the calculation)
- Differences in the manipulation with the torque wrench
(e.g. fast or slow tightening of the screw)
- The distribution of the torque wrench itself.

Depending on how the above-mentioned influences are controlled, the tightening factor α_A must be selected.

Example:

If a commercially available torque wrench with an electronic display is used, a tightening factor $\alpha_A = 1.4 - 1.6$ must be reckoned with.

The selection is:

$\alpha_A = 1.4$ (see Table 2 in chapter 6 “Reference values for the tightening factor ...”)

D) Preload force F_{Vmin}

Example:

In Table 5 in chapter 6 in column $\mu_G = 0.14$, line M12 and strength class 8.8 read off the value for the maximum preload force $F_{Vmax} = 41.9 \text{ KN}$ in the area “Assembly preload forces”.

The minimum preload force F_{Vmin} is obtained by dividing F_{Vmax} by the tightening factor α_A .

$$\text{Preload force } F_{Vmin} = \frac{41.9 \text{ KN}}{1.4}$$

$$F_{Vmin} = 29.92 \text{ KN}$$

E) Control of the results

You should ask yourself the following questions!

- Is the residual clamping power sufficient?
- Is the minimum probable preload force F_{Vmin} sufficient for the maximum forces that occur in practice?

6.8 Pairing different element/contact corrosion

The following rule applies for preventing contact corrosion:

In each case fasteners must have at least the same corrosion resistance as the parts that are to be connected. If fasteners of equal value cannot be selected, they must be of higher value than the parts to be connected.

Pairing different fasteners/component materials with regard to contact corrosion

Component material/surface*	Stainless steel A2/A4	Aluminium	Copper	Brass	Steel, galvanised, black pass.	Steel, galvanised, yellow chromated	Steel, galvanised, blue pass.	Steel, bright
Stainless steel A2/A4	+++	+++	++	++	++	++	++	++
Aluminium	++	+++	++	++	+	+	+	+
Copper	+	+	+++	++	+	+	+	+
Brass	+	+	++	+++	+	+	+	+
Steel, galvanised, black passivated	-	-	-	-	+++	++	++	+
Steel, galvanised, yellow chromated	--	--	--	--	+	+++	++	+
Steel, galvanised, blue passivated	--	--	--	--	+	+	+++	+
Steel, bright	---	---	---	---	--	--	--	+++

+++ Highly recommended pairing
 ++ Recommended pairing
 + Moderately recommended pairing
 - Less recommended pairing
 -- Not recommended pairing
 --- Pairing not recommended under any circumstances
 * This assumption applies with a surface ratio (component ratio of fastener to the part to be connected) between 1:10 and 1:40.

Tab. 9

6.9 Static shearing forces for slotted spring pin connections

Slotted spring pins, heavy duty in accordance with ISO 8752 (DIN 1481)

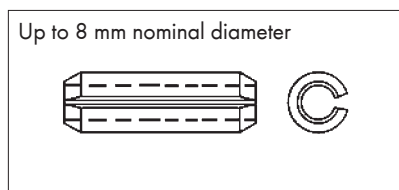

Fig. AU

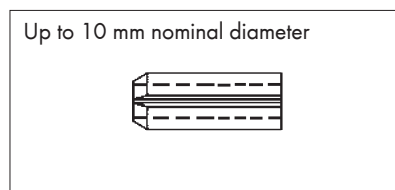

Fig. AV

Material:
Spring steel hardened
from 420 to 560 HV

Nominal diameter [mm]	1	1.5	2	2.5	3	3.5	4	4.5	5	6	8	10	12	13	14	16	18	20	
Shearing force min. [kN]	Single-shear	0.35	0.79	1.41	2.19	3.16	4.53	5.62	7.68	8.77	13	21.3	35	52	57.5	72.3	85.5	111.2	140.3
	Two-shear	0.7	1.58	2.82	4.38	6.32	9.06	11.2	15.4	17.5	26	42.7	70.1	104.1	115.1	144.1	171	222.5	280.6

Tab. 10

Spring-type straight pins, standard design in accordance with ISO 8750 (DIN 7343)

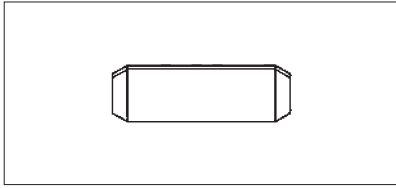

Material:
Spring steel hardened
from 420 to 520 HV

Fig. AW

Nominal diameter [mm]		0.8	1	1.2	1.5	2	2.5	3	3.5	4	5	6	8	10	12	14	16
Shearing force min. [kN]	Single-shear	0.21	0.3	0.45	0.73	1.29	1.94	2.76	3.77	4.93	7.64	11.05	19.6	31.12	44.85	61.62	76.02
	Two-shear	0.40	0.6	0.90	1.46	2.58	3.88	5.52	7.54	9.86	15.28	22.1	39.2	62.24	89.7	123.2	152

Tab. 11

Spring-type straight pins, coiled, heavy duty in accordance with ISO 8748 (DIN 7344)

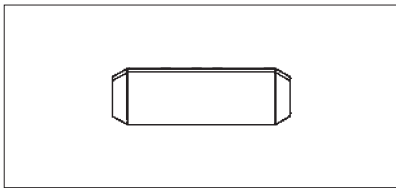

Material:
Spring steel hardened
from 420 to 520 HV

Fig. AX

Nominal diameter [mm]		1.5	2	2.5	3	4	5	6
Shearing force min. [kN]	Single-shear	0.91	1.57	2.37	3.43	6.14	9.46	13.5
	Two-shear	1.82	3.14	4.74	6.86	12.2	18.9	27

Tab. 12

Spring-type straight pins, slotted, light duty in accordance with ISO 13337 (DIN 7346)

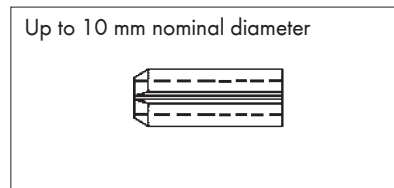
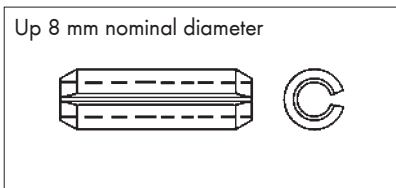

Material:
Spring steel hardened
from 420 to 560 HV

Fig. AY

Fig. AZ

Nominal diameter [mm]		2	2.5	3	3.5	4	4.5	5	6	7	8	10	11	12	13	14	16	18	20
Shearing force min. [kN]	Single-shear	0.75	1.2	1.75	2.3	4	4.4	5.2	9	10.5	12	20	22	24	33	42	49	63	79
	Two-shear	1.5	2.4	3.5	4.6	8	8.8	10.4	18	21	24	40	44	48	66	84	98	126	158

Tab. 13

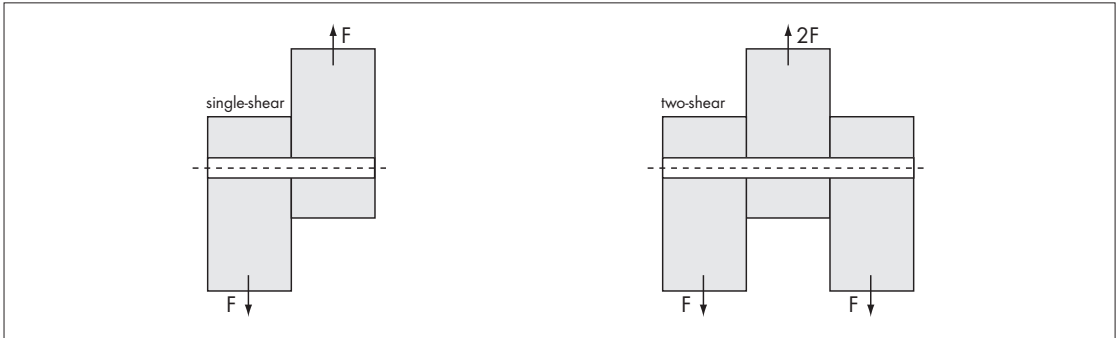

Fig. BA

6.10 Design recommendations for internal drives for screws

Technical progress and financial considerations are leading worldwide to an almost complete replacement of straight slot screws by internal drives.

AW drive

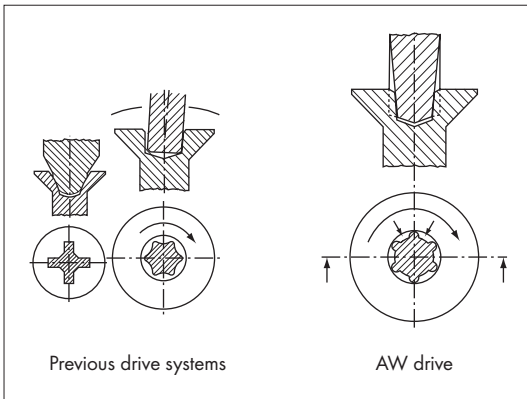

Fig. AR

AW drive system

Advantages with regard to previous drive systems:

- Improved force transmission by means of the conical multipoint head.
- Longer service life through optimal fit.
- Optimum centring through the conical course of the bit.
- Greatest possible bearing surface of the bit in the screw drive → comeout.
- Comeout = zero. The even force distribution prevents damage to the surface protective layer and thus guarantees greater corrosion resistance.

Hexagonal socket

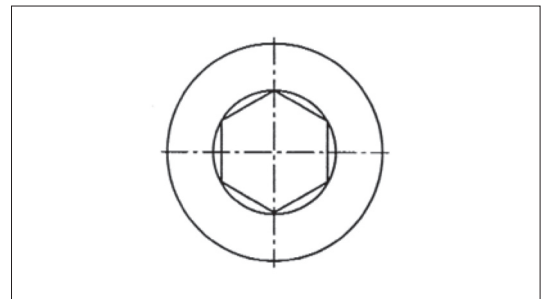

Fig. AS

Good force transmission through several points of application of force. Hexagonal socket-screws have smaller widths across flats than hexagon head screws, which also means more economic designs because of smaller dimensions.

Cross recess Z (pozi drive) in accordance with ISO 4757

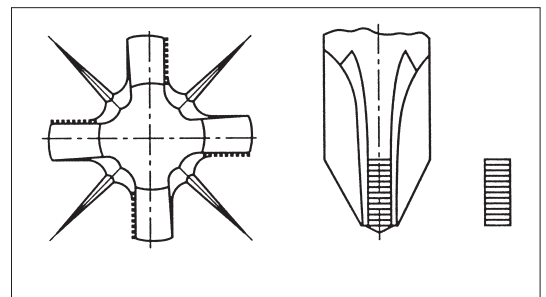

Fig. AT

The four "tightening walls" in the cross recess, with which the screwdriver is in contact when the screw is being screwed in, are vertical. The remaining walls and ribs are slanted. This can improve ease of assembly if the cross recesses are made optimally. Pozi drive screwdrivers have rectangular blade ends.

Cross recess H (Phillips) in accordance with ISO 4757

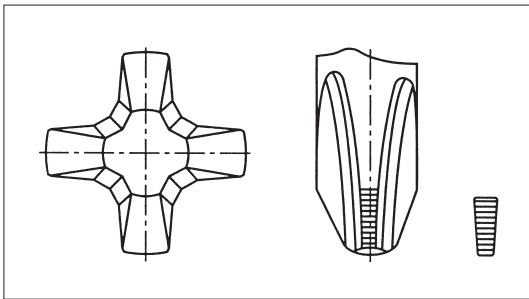

Fig. AU

Normal cross recess in which all walls and ribs are slanted, whereby the screwdriver has trapezoid blade ends.

6.11 Assembly Torque method

The required preload force is generated by the measurable torque MV. The tightening appliance that is used (e.g. a torque wrench) must have uncertainty of less than 5%.

Angular momentum method

The connections are tightened with the help of an impulse or impact driver with an uncertainty of less than 5%. The tightening appliances are to be adjusted as far as possible to the original screw assembly in a suitable manner (e.g. retightening method or length measuring method).

Retightening method: the connection is tightened first of all with the screwdriver and then retightened/checked with a precision torque wrench. Length measuring method: the resulting lengthening of the screw is checked (measuring calliper), whereby the lengthening of the screw has to be calibrated beforehand on a screw test stand.

Angle of rotation method

Prerequisite is that the parts to be joined rest largely flat on each other. The pre-tightening torque is applied with one of the two methods described above. Mark the position of the nut relative to the screw shaft and component clearly and permanently, so that the subsequently applied further tightening angle of the nut can be determined easily. The required further tightening angle must be determined by means of a method test at the respective original screwed connections (e.g. by means of screw lengthening).



Fig. W