

CONNECT

VOLUME II

Riveting Technology



CONTENTS

Introduction	4
1. Riveting as a joining method	5
2. Blind rivets	6
2.1. Blind rivets – Material combinations	6
2.2. Blind rivets – Corrosion protection	7
2.3. Blind rivets – Product standards	7
2.4. Blind rivets – Mechanical properties	8
2.5. Blind rivets – Tensile fracture force in blind rivets according to ISO standards	9
2.6. Blind rivets – Shear fracture force in blind rivets according to ISO standards	10
2.7. Blind rivets – Component preparation	11
2.8. Blind rivets – Clamping range	11
2.9. Blind rivets – Edge distance	12
2.10. Blind rivets – Installation	12
2.11. Blind rivets – Additional installation instructions	13
2.12. Blind rivets – Installation tools	14
2.13. Blind rivets – Removing blind rivet joints	15
2.14. Blind rivets – Checking blind rivet joints	16
2.15. Blind rivets – Blind rivet systems	16
3. Solid rivets	18
3.1. Solid rivets – Materials	18
3.2. Solid rivets – Corrosion protection	18
3.3. Solid rivets – Standardized variants	18
3.4. Solid rivets – Component preparation	19
3.5. Solid rivets – Clamping range	19
3.6. Solid rivets – Installation	20
3.7. Solid rivets – Checking	20
4. Functional blind rivet element, blind rivet nut	21
4.1. Blind rivet nuts – Materials and corrosion protection coatings	21
4.2. Blind rivet nuts – Types	21
4.3. Blind rivet nuts – Installation principle	22
4.4. Blind rivet nuts – Joining properties	23
4.5. Blind rivet nuts – Mechanical properties	23
4.6. Blind rivet nuts – Clamping range	23
4.7. Blind rivet nuts – Component preparation	24
4.8. Blind rivet nuts – Additional installation instructions	24
4.9. Blind rivet nuts – Installation tools	25
4.10. Blind rivet nuts – Repair possibilities	26
4.11. Blind rivet nuts – Quality assurance	26
4.12. Blind rivet nuts – Special form	27
5. Functional blind rivet element, blind rivet studs	28
5.1. Blind rivet studs – Materials and corrosion protection coatings	28
5.2. Blind rivet studs – Types	28
5.3. Blind rivet studs – Installation principle	29
5.4. Blind rivet studs – Joining properties	29

5.5.	Blind rivet studs – Mechanical properties	30
5.6.	Blind rivet studs – Clamping range	30
5.7.	Blind rivet studs – Component preparation	30
5.8.	Blind rivet studs – Installation instructions	30
5.9.	Blind rivet studs – Installation tools	31
5.10.	Blind rivet studs – Repair possibilities	31
5.11.	Blind rivet studs – Quality assurance	31
6.	Other riveting elements	33
6.1.	Fault causes and effects on riveted joints	34

INTRODUCTION

Compared to a screw connection, riveting has the advantage that a thread does not have to be introduced into any of the components being connected, or no nut needs to be (un)screwed.

This means that the subject of the underhead or thread friction coefficients do not play a role, which in turn plays a very important role in screw connections.

A rivet is usually a cylindrical metal bolt with an end that is thickened on one side, the setting head. Installation is done by inserting the rivet shank through a slightly oversized hole until the setting head rests on the component surface. The end of the shank is reshaped and the locking head is formed by applying continuous or sudden pressure.

While solid rivets, the origins of which go back to the Bronze Age, used to play an important role in sectors such as shipbuilding, steel construction and many other areas, this classic form is only used occasionally today.

In vehicle construction, light construction and multi-material connections have brought some innovations to riveting in recent years. Self-pierce riveting with solid or semi-tubular rivets are now widespread in series car production. In this process, the rivet is both a tool and a fastening element combined. It is punched through the components being joined and joins them positively. For this type of joining, access to the joint from both sides is essential. This also requires very complex and costly installation tools. This process is therefore primarily used only in large-scale production.

One rivet variant that can be installed with simple and inexpensive installation tools is the blind rivet. Users can choose from a large number of material combinations and head shapes, as well as special shapes. The use of blind rivets is therefore widespread today in mechanical engineering, sheet metalworking, plant construction, shelving and metal construction. Simple and thus quick and low-cost rivet installation has helped this installation variant to become widespread.

The field of riveting technology has been enriched by functional elements in recent years. A wide range of what are known as blind rivet nuts or blind rivet threaded bolts is also available today for making joints with additional functions.

1. Riveting as a joining method

According to DIN 8593-5:2003-09, riveting is a process for joining components in which either the parts being joined or auxiliary parts are reshaped locally or entirely. The forces required for the reshaping are for the most part generated by mechanical, hydraulic or electromagnetic work. A joint established in this way is generally secured against unintentional loosening by a positive fit.

Classification and definition of the riveting process

Joining by riveting processes (DIN 8593-5:2003-09)		
Designation	Definition	Image
Riveting	Joining by upsetting a bolt-shaped auxiliary joining part (the rivet).	
Tubular riveting	Joining by folding over protruding parts of a tubular rivet.	
Tenon riveting	Joining by upsetting the tenon-like end on one of the two parts being joined.	
Tubular tenon riveting	Joining by upsetting projecting parts of the tubular tenon-like end on one of the two parts being joined.	
Intermediate tenon riveting	Joining by upsetting an intermediate tenon on one of the two parts being joined.	
Punch rivets	Joining by spreading in an auxiliary joining part (e.g. semi-tubular or solid punch rivet).	
		

Table 1: Classification of the riveting processes

2. Blind Rivets

Compared with solid rivets, blind rivets have the advantage that they can also be used in structures that are only accessible from one side. Installation is done in a setting operation. Blind rivets consist of two parts, a blind rivet sleeve and a rivet mandrel.

Blind rivet sleeve:

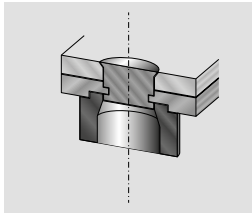
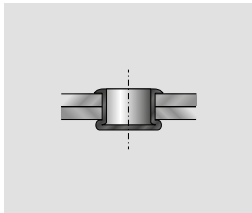
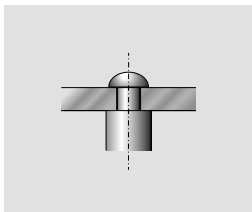
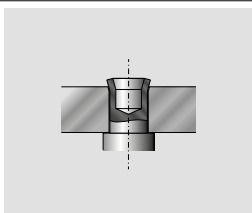
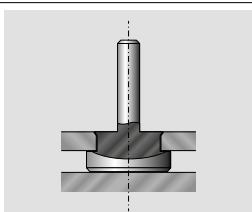
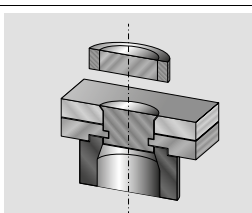
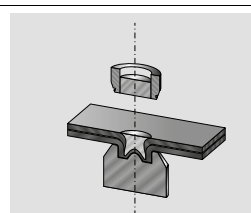
The blind rivet sleeve is divided into the blind rivet setting head, which is always on the installation side and can differ in size and shape, and the blind rivet shank, the length of which depends on the material thickness being riveted. Blind rivet sleeves can be designed with an open shank or with a closed shank. Blind rivets with a closed shank are often also called cup blind rivets.

Rivet mandrel:

The task of the rivet mandrel head is to reshape the shank of the blind rivet sleeve. It usually has a predetermined breaking point at which the rivet mandrel breaks after the blind rivet sleeve has been reshaped. The part of the rivet mandrel remaining in the blind rivet sleeve is referred to as the residual rivet mandrel. The rivet mandrel shaft is the part of the rivet mandrel that has to be disposed of. The rivet mandrel can be smooth or grooved (usually the case with higher-strength blind rivets)

Locking head:

The locking head is formed by the reshaping of the part of the blind rivet sleeve that is opposite the setting head when the blind rivet is installed by the rivet mandrel.

Blind rivet designations

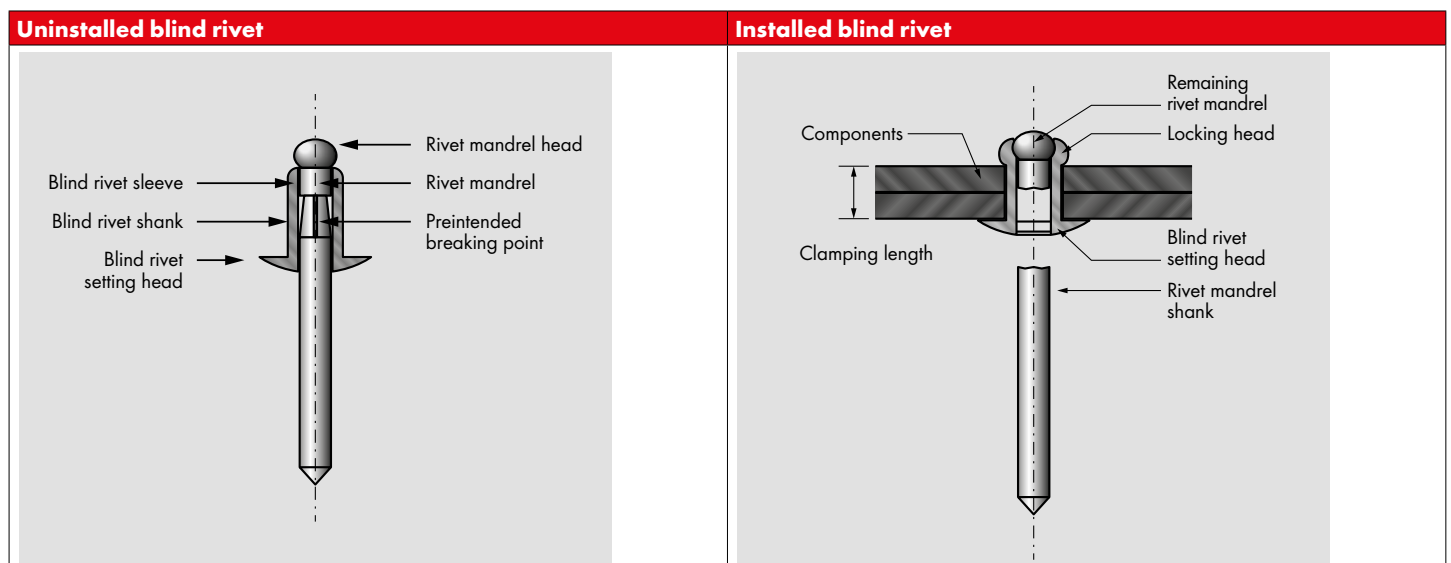

Picture 1: Blind rivet designations

2.1. Blind rivets – Material combinations

Most blind rivets are made of metallic materials. The blind rivet sleeve and the rivet mandrel can be made either of the same material or different material types.

All parameters relevant to the joint must be taken into account when selecting the most suitable material combination for the respective application. For example corrosive stress, tensile and shear stress, static, cyclic or dynamic stress, thermal stress. The materials are usually cited in the short form specified in the standard. The material of the blind rivet sleeve is shown first, and the material of the rivet mandrel is shown second.

Example: A1A/St (blind rivet sleeve aluminum alloy/rivet mandrel steel)

Common material combinations for blind rivets

Blind rivet sleeve	Rivet mandrel
Aluminum alloy (Al new A1A)	Aluminum alloy, steel (St) or stainless steel (SSt)
Copper (Cu)	Bronze, steel (St) or stainless steel (SSt)
Steel (St)	Steel (St) or stainless steel (SSt)
Stainless steel (A2 or A4)	Steel (St) or stainless steel (SSt)
Nickel-copper alloy (NiCu)	Steel (St) or stainless steel (SSt)
Copper-nickel alloy (CuNi)	Steel (St) or stainless steel (SSt)

Table 2: Common material combinations



2.2. Blind rivets – Corrosion protection

The standard corrosion protection coating for steel blind rivet sleeves and blind rivet mandrels is zinc plated with a transparent or bluish passivation.

Blind rivet sleeves and blind rivet mandrels made of stainless steels, aluminum alloys or other non-ferrous alloys are usually used without an additional coating (bare).

2.3. Blind rivets – Product standards

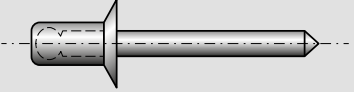
The blind rivets listed below have thus far been regulated by standards:

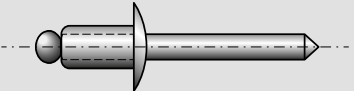
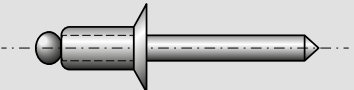
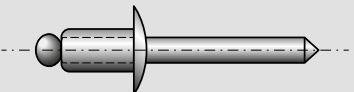
Designation	ISO standard	Previous DIN standard	Material combination	View
Closed end blind rivets with break pull mandrel and protruding head	15973	none	A1A/St	
Closed end blind rivets with break pull mandrel and countersunk head	15974	none	A1A/St	
Closed end blind rivets with break pull mandrel and protruding head	15975	none	A1A/A1A	
Closed end blind rivets with break pull mandrel and protruding head	15976	none	St/St	
Open end blind rivets with break pull mandrel and protruding head	15977	7337 Form A	A1A/St	
Open end blind rivets with break pull mandrel and protruding head	15978	7337 Form B	A1A/St	
Open end blind rivets with break pull mandrel and protruding head	15979	7337 Form A	St/St	

Designation	ISO standard	Previous DIN standard	Material combination	View
Open end blind rivets with break pull mandrel and protruding head	15980	7337 Form B	St/St	
Open end blind rivets with break pull mandrel and protruding head	15981	7337 Form A	A1A/A1A	
Open end blind rivets with break pull mandrel and protruding head	15982	7337 Form B	A1A/A1A	
Open end blind rivets with break pull mandrel and protruding head	15983	7337 Form A	A2/A2	
Open end blind rivets with break pull mandrel and protruding head	15984	7337 Form B	A2/A2	
Open end blind rivets with break pull mandrel and protruding head	16582	7337 Form A	Cu/St or Cu/Br or Cu/SSt	
Open end blind rivets with break pull mandrel and protruding head	16583	7337 Form B	Cu/St or Cu/Br or CU/SSt	
Open end blind rivets with break pull mandrel and protruding head	16584	7337 Form A	NiCu/St or NiCu/SSt	
Closed end blind rivets with break pull mandrel and protruding head	16585	none	A2/SSt	

Table 3: Standardized blind rivets

2.4. Blind rivets – Mechanical properties

The test procedures for blind rivets according to current ISO standards are regulated in ISO 14589. This standard regulates the framework conditions that apply, for example when determining the tensile and shear forces.

Tensile stress test:

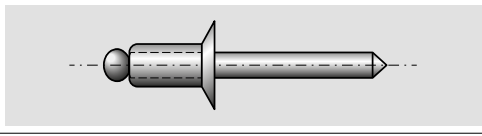
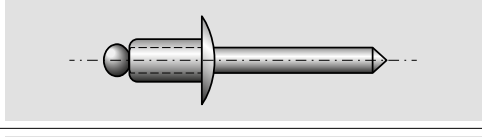
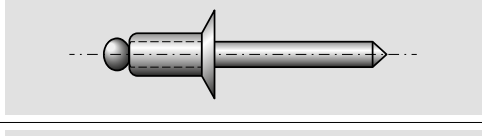
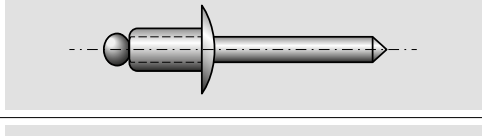
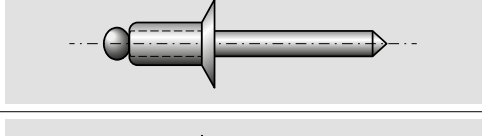
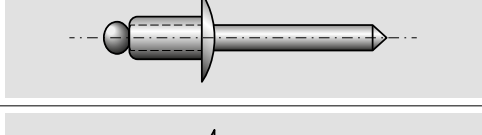
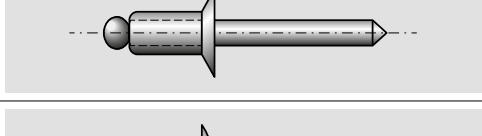
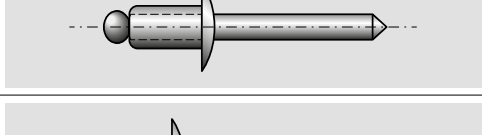
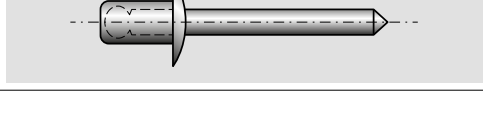
Load is evenly applied to a blind rivet in the longitudinal axis until it fails completely. The values determined serve as guide values and not as design criteria for joints on real components.

Shear stress:

Load is evenly applied to a blind rivet perpendicular to its longitudinal axis until it fails completely. The values determined serve as guide values and not as design criteria for joints on real components.

The remaining mandrel must be removed when determining the installation parameters. The exception is blind rivets with a supporting residual mandrel.

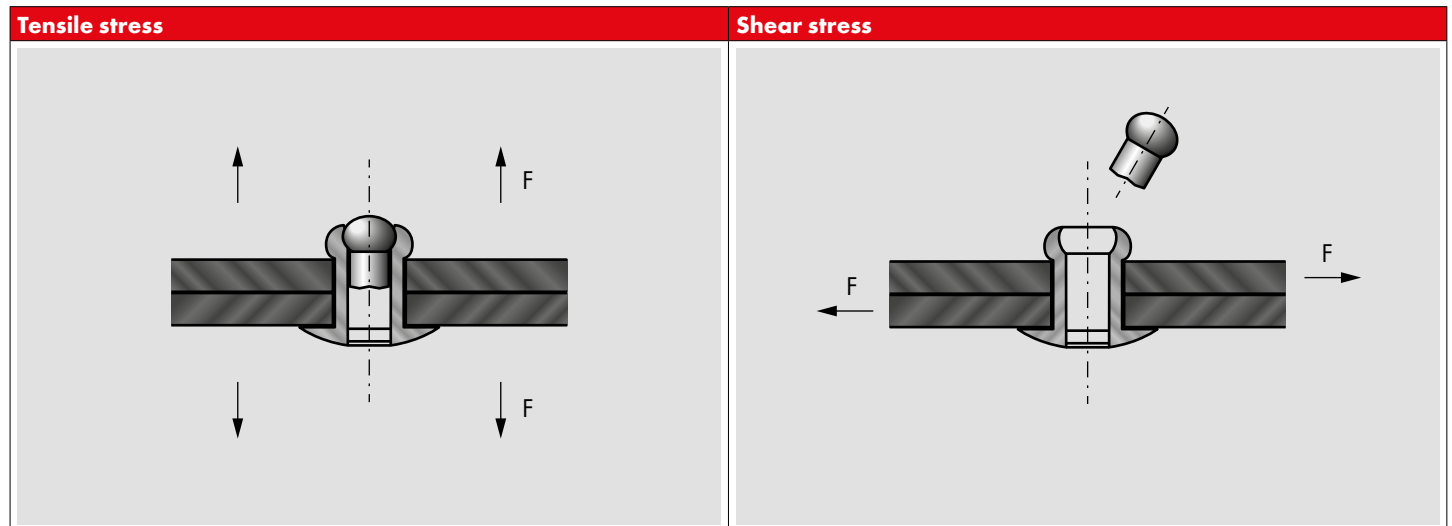

Picture 2: Direction of stress

2.5. Blind rivets – Shear force in blind rivets according to ISO standards

The following table contains the minimum tensile forces in newtons (N) that apply to ISO rivets:

ISO standard/material combination	Strength class	Nominal diameter (mm)							
		2.4	3.0	3.2	4.0	4.8	5.0	6.0	6.4
ISO 15973 A1A/St	-	-	-	1,450	2,200	3,100	-	-	4,900
ISO 15974 A1A/St	-	-	-	1,450	2,200	3,100	-	-	-
ISO 15975 A1A/A1A	-	-	-	540	760	1,400	-	-	-
ISO 15976 St/St	-	-	-	1,300	1,550	2,800	-	-	4,000
ISO 15977 A1A/St	L	350	550	700	1,200	1,700	2,000	3,000	3,150
	H	550	850	1,100	1,800	2,600	3,100	4,600	4,850
ISO 15978 A1A/St	L	359	550	700	1,200	1,700	2,000	-	-
	H	550	850	1,100	1,800	2,600	3,100	-	-
ISO 15979 St/St	-	700	1,100	1,200	2,200	3,100	4,000	4,800	5,700
ISO 15980 St/St	-	700	100	1,200	2,200	3,100	4,000	4,800	5,700
ISO 15981 A1A/A1A	-	350	-	670	1,020	1,420	-	-	2,490
ISO 15982 A1A/A1A	-	350	-	670	1,020	1,420	-	-	2,490
ISO 15983 A2/A2	-	-	2,200	2,500	3,500	5,000	5,800	-	-
ISO 15984 A2/A2	-	-	2,200	2,500	3,500	5,000	5,800	-	-
ISO 16582 Cu/St or Cu/Br or Cu/SSt	-	-	950	1,000	1,800	2,500	-	-	-
ISO 16583 Cu/St or Cu/Br or CU/SSt	-	-	950	1,000	1,800	2,500	-	-	-

ISO standard/material combination	Strength class	Nominal diameter (mm)							
		2.4	3.0	3.2	4.0	4.8	5.0	6.0	6.4
ISO 16584 NiCu/St or NiCu/SSt	-	-	-	1,900	3,000	3,700	-	-	6,800
ISO 16585 A2/SSt	-	-	-	2,200	3,500	4,400	-	-	8,000

Table 4: Minimum tensile forces

2.6. Blind rivets – Shear fracture force in blind rivets according to ISO standards

The following table contains the minimum shear forces in newtons (N) that apply to ISO rivets:

ISO standard/material combination	Strength class	Nominal diameter (mm)							
		2.4	3.0	3.2	4.0	4.8	5.0	6.0	6.4
ISO 15973 A1A/St	-	-	-	1,100	1,600	2,200	-	-	3,600
ISO 15974 A1A/St	-	-	-	1,100	1,600	2,200	-	-	-
ISO 15975 A1A/A1A	-	-	-	460	720	1,000	-	-	-
ISO 15976 St/St	-	-	-	1,150	1,700	2,400	-	-	-
ISO 15977 A1A/St	L	250	400	500	850	1,200	1,400	2,100	2,200
	H	350	550	750	1,250	1,850	2,150	3,200	3,400
ISO 15978 A1A/St	L	250	400	500	850	1,200	1,400	-	-
	H	350	550	750	1,250	1,850	2,150	-	-
ISO 15979 St/St	-	650	950	1,100	1,700	2,900	3,100	4,300	4,900
ISO 15980 St/St	-	650	950	1,100	1,700	2,900	3,100	4,300	4,900
ISO 15981 A1A/A1A	-	250	-	500	850	1,160	-	-	2,050
ISO 15982 A1A/A1A	-	250	-	500	850	1,160	-	-	2,050
ISO 15983 A2/A2	-	-	1,800	1,900	2,700	4,000	4,700	-	-
ISO 15984 A2/A2	-	-	1,800	1,900	2,700	4,000	4,700	-	-
ISO 16582 Cu/St or Cu/Br or Cu/SSt	-	-	760	800	1,500	2,000	-	-	-
ISO 16583 Cu/St or Cu/Br or CU/SSt	-	-	760	800	1,500	2,000	-	-	-
ISO 16584 NiCu/St or NiCu/SSt	-	-	-	1,400	2,200	3,300	-	-	5,500
ISO 16585 A2/SSt	-	-	-	2,000	3,000	4,000	-	-	6,000

Table 5: Minimum shear forces

2.7. Blind rivets – Component preparation

The rivet hole diameters required for the respective nominal rivet diameter can be produced without cutting by means of punching or laser beam processes (or other beam processes), or by cutting in the form of drilling. When making the rivet holes, it must be ensured that the permissible rivet hole tolerances are adhered to.

The rivet hole must be free of burrs before the rivet is installed. The contact surface of the blind rivet setting head must be free of chips and other impurities.

Make sure that the contact surface is level and at right angles to the rivet hole.

The rivet hole diameter can be found in the respective product standard or can be easily determined using the formulae below.

Blind rivet sleeve nominal diameter + 0.1 mm

The following is an overview of the nominal rivet diameters regulated in the standards and the rivet hole diameters required for them.

Nominal diameter (mm)	2.4	3.0	3.2	4.0	4.8	5.0	6.0	6.4
d_h Drill hole dia.	2.5	3.1	3.3	4.1	4.9	5.1	6.1	6.5
Tolerance (mm)	+ 0.1							

Table 6: Drilling diameter

2.8. Blind rivets – Clamping range

When selecting a blind rivet for joining components, it is essential to ensure compliance with the clamping range defined in the standard or specified by the manufacturer. The clamping range of a blind rivet is defined by the difference between the minimum component thickness being worked with ($t_{tot, min}$) and the maximum component thickness being worked with ($t_{tot, max}$). It should also be ensured that the minimum and maximum clamping range is not fully used. In such cases, tolerances and influences often lead to problems and unsatisfactory results.

Diagram illustrating the clamping range

Minimum clamping range Maximum clamping range

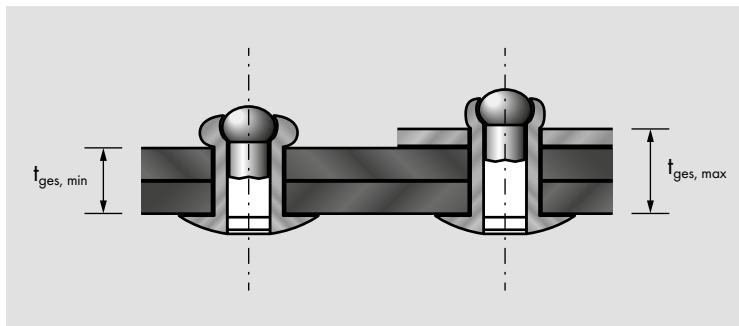

Picture 3: Clamping range

2.9. Blind rivets – Edge distance

For the highest possible strength of the rivet joint, the distance from the central axis of the rivet to the edge of the component should not be less than 2 x the diameter of the blind rivet shank.

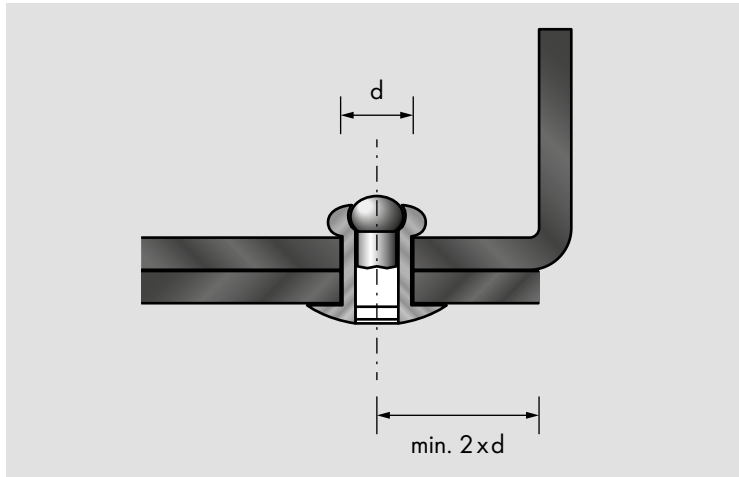

Picture 4: Edge spacing

2.10. Blind rivets – Installation

Blind rivet installation is divided into four work steps:

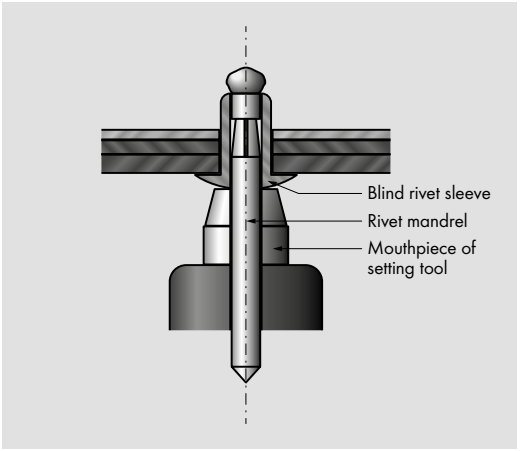
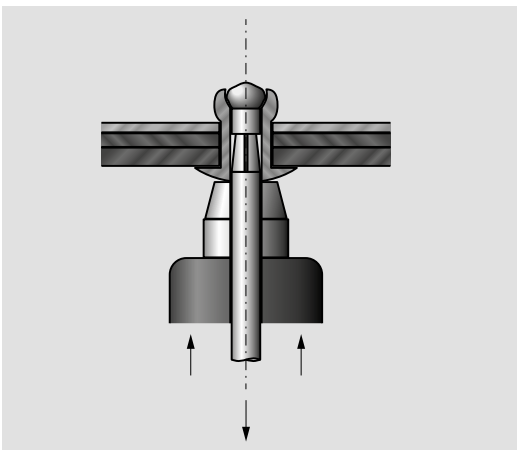
Step	Description	Diagram
1	The blind rivet is inserted into the hole in the component and the setting head rests on it.	 <p>Blind rivet sleeve Rivet mandrel Mouthpiece of setting tool</p>
2	The rivet mandrel is drawn by means of an installation tool, whereby the rivet mandrel head slips into the blind rivet sleeve - the force curve rises steeply until the rivet mandrel head is supported on the component via the blind rivet sleeve.	

Step	Description	Diagram
3	The components are drawn together (clamped). The force curve rises steeply until the rivet mandrel breaking force is reached.	
4	The rivet mandrel has torn off at the predetermined breaking point, and the rivet mandrel shank is disposed of. The installation process is complete.	

Table 7: Installation steps

2.11. Blind rivets – Additional installation instructions

Joining hard and soft materials

Hard and soft materials are usually joined using large-head rivets. Compared with standard rivets, large-head rivets have an enlarged dome head. This enables a higher surface pressure to be achieved. Alternatively, so-called soft-claw blind rivets or break-stem rivets are often used.

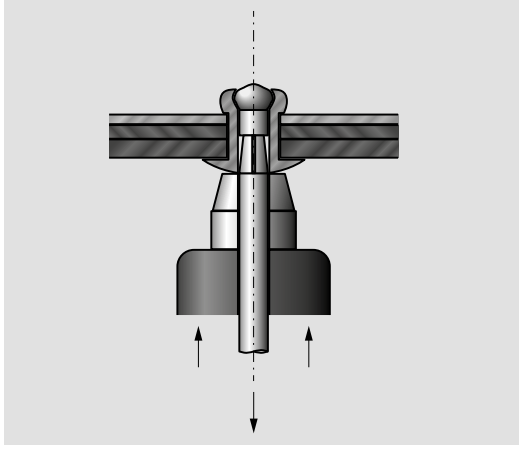
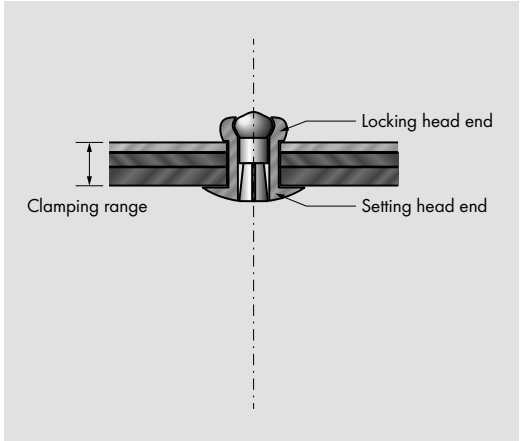
Sealed blind rivets/Closed-end blind rivets

Closed blind rivets are also often called closed-end blind rivets or sealed blind rivets. The bucket-shaped (closed-end) blind rivet sleeve is pressed over the rivet mandrel head during the setting procedure. The remaining rivet mandrel is thus captively integrated into the rivet mandrel sleeve. If the drill hole preparation and rivet installation are done correctly, the rivet joint is splash-proof. If higher demands are placed on the leakproofing, additional measures such as sealing washers under the blind rivet setting head or downstream sealing measures with chemical sealants must be taken.

Self-drilling rivets

The self-drilling rivet is a special variant of the blind rivet. The two work steps, drilling the hole and setting the rivet, are done with a single functional element, the drilling blind rivet. As a result, the time required to create a rivet joint can be significantly reduced. The need for installation tools is also reduced. Installation is done with an attachment that is compatible with common drill chucks of cabled or cordless drills.





Blind rivets with large dome head	Breakstem rivets (all-purpose rivet)	Soft Claw Blind Rivet	Drilling blind rivet
			

Table 8: Special blind rivet types

2.12. Blind rivets – Installation tools

The choice of a suitable and economical installation tool should take into account the following criteria:

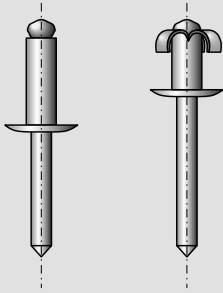
- Rivet nominal diameter
- Rivet material combination
- Force required to set the rivet
- Number of rivets to be installed
- Accessibility of the rivet location
- Ambient conditions at the installation location

Particular attention should be paid to using the correct mouthpiece. The mouthpiece diameter must match the blind rivet mandrel diameter. The chuck jaws should also be cleaned regularly and replaced when worn. Abrasion cannot be avoided, especially with zinc-plated blind rivet mandrels, and must be regularly removed from the chuck jaws and thus eliminated from the mechanics of the installation tool.

See below for an overview of common installation tool:

Installation tool	Image	Note
Manual riveting tool		<ul style="list-style-type: none"> • Easy to use • Low-cost • For aluminum rivets up to max. 5 mm in diameter • For steel and stainless steel rivets up to max. 4 mm in diameter
Lever-action riveting tool		<ul style="list-style-type: none"> • Easy to use • For rivets made of all materials up to 6.4 mm in diameter
Cordless blind riveting tool		<ul style="list-style-type: none"> • Easy to use • For rivets made of all materials. The max. nominal diameters that can be installed depend on the tool • Suitable for series rivet installation • Can be used flexibly and independently of a stationary energy supply



Installation tool	Image	Note
Pneumatic blind riveting tool		<ul style="list-style-type: none"> • Easy to use • For rivets made of all materials. The max. nominal diameters that can be installed depend on the tool • Suitable for series rivet installation • Continuous compressed air supply required
Blind riveting attachment for cordless or corded power tools		<ul style="list-style-type: none"> • Easy to use • Low cost • Suitable for standard blind rivets and self-drilling rivets • For rivets made of all materials. The max. nominal diameters that can be installed depend on the tool • Suitable for series rivet installation • Can be used flexibly and independently of a stationary energy supply

Table 9: Installation tools

2.13. Blind rivets – Removing blind rivet joints

Standard blind rivets can be drilled out in most cases. The blind rivet sleeve, which is usually not completely filled with the remaining rivet mandrel ensures good fixation and guidance of the drill. The nominal diameter of the drill should be identical to the shank diameter of the blind rivet sleeve.

High-strength blind rivets with locked rivet mandrels must be dismantled in two steps. In step one, the remaining rivet mandrel is knocked out with a punch/splint driver. The rivet sleeve can be drilled out in the second step. The nominal diameter of the drill should be identical to the shank diameter of the blind rivet sleeve.

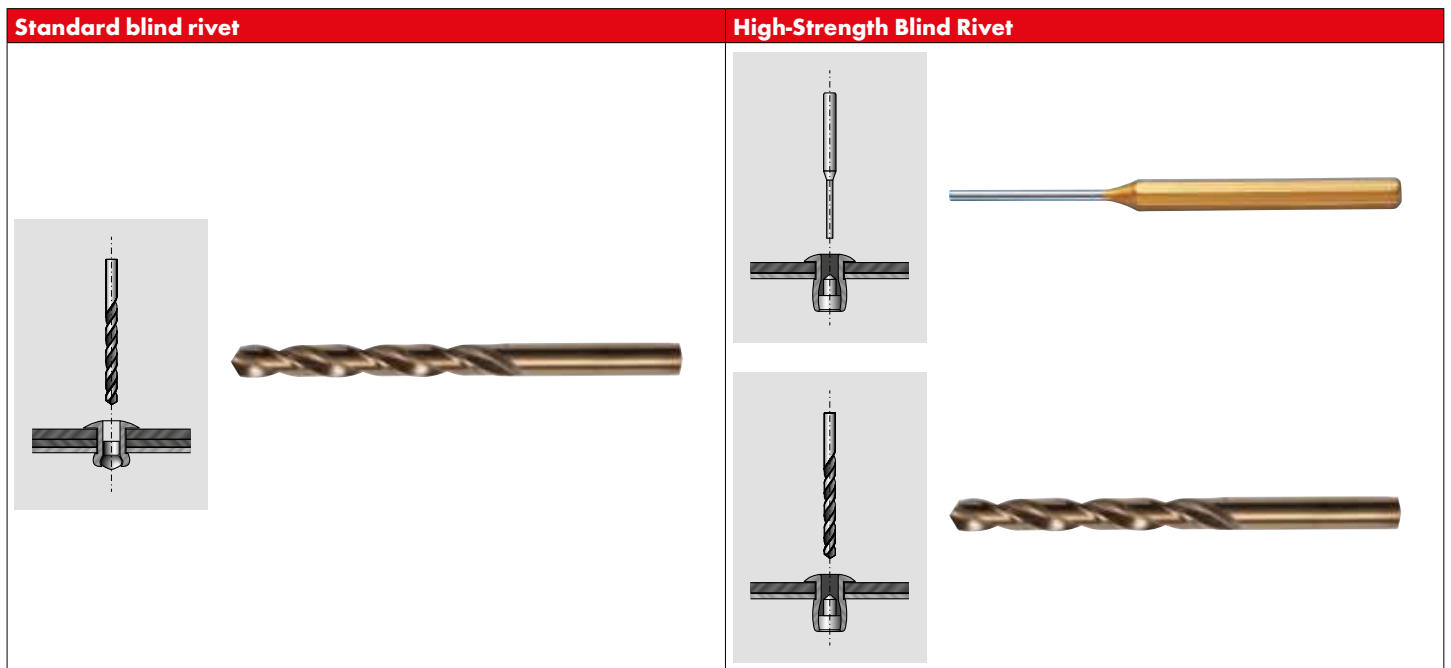

Picture 5: Removing blind rivets

2.14. Blind rivets – Testing blind rivet joints

Non-destructive and destructive methods can be used to test the joint quality.

Non-destructive test

Blind rivets are self-regulating connecting elements, as the rivet mandrel only breaks off as soon as the locking head of the blind rivet connection is fully formed and the maximum rivet mandrel breaking load has been reached.

It is essential for the user to ensure that the following requirements are met in order to obtain a perfect result:

- Adherence to the correct drill hole tolerance
- Adherence to the permissible clamping range
- Flat setting head contact
- Joining gaps prevented

A visual inspection can be used to check whether the remaining rivet mandrel protrudes at the setting head or whether the remaining rivet mandrel has not remained in the blind rivet sleeve. In addition, correct placement of the setting head can also be checked visually or, if necessary, with the aid of a feeler gage.

If all of the points mentioned are adhered to, a general statement can be made about the joint.

Destructive test

The design of the joining element can be checked by means of a macro-section. To do this however, it is necessary to identically simulate the real installation state or even to carry out the test on original components. Particular attention should be paid to the following points during this test:

- The area between the blind rivet setting head and the component contact surface at the setting head end should be free of gaps.
- As symmetrical as possible shaping of the locking head.
- Gap-free area between the formed locking head and the component contact surface.
- Rivet should be straight inside the drill hole.
- Drill hole should be filled in.
- In the case of high-strength blind rivets, it must be ensured that the rivet mandrel break lies above the plane of the part being joined.

2.15. Blind rivets – Blind rivet systems

Pictorial representation of the locking head design of some blind rivet systems, most of which are not regulated by standards:

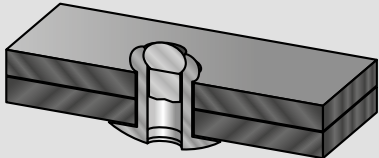
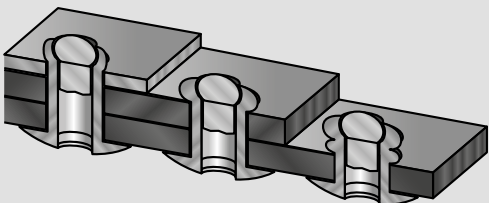
Presentation	Declaration
	<p>Standard blind rivet: Manufactured in accordance with ISO standards. On the set blind rivet, a residual rivet mandrel remains in the blind rivet sleeve or in the locking head.</p>
	<p>Multigrip blind rivet: The blind rivet sleeve is specially designed to ensure large clamping areas.</p>

Presentation	Declaration
	<p>Expanding blind rivet: The rivet mandrel head is usually specially shaped to ensure a star-shaped separation of the blind rivet sleeve. In some types, the blind rivet shank also has longitudinal notches to ensure star-shaped deformation. When the rivet is set, the tabs fold over in an arc and form the locking head. In some types, the remaining rivet mandrel stays in the blind rivet sleeve after the setting procedure.</p>
	<p>Triple claw blind rivet: The blind rivet sleeve is slotted in the axial direction, which means that several tabs are formed on the locking head side when the rivet is set. This distributes the contact pressure of the locking head over a larger area.</p>
	<p>Sealed blind rivet: Because of the closed blind rivet sleeve, this type is also called closed-end blind rivet or sealed blind rivet. A splash-proof rivet connection is formed after a correct setting procedure.</p>
	<p>High-strength blind rivet with a conical locking head: High-strength and vibration-proof joints of components can be made using high-strength blind rivets with a conical mandrel head (locking head).</p>
	<p>High-strength blind rivet with a bead-shaped locking head: High-strength blind rivets with a round mandrel head (locking head) are particularly suitable for joining thin-walled components. The large locking head ensures a high-strength and secure joint between the components.</p>

Table 10: Blind rivet systems

3. Solid rivets

Solid rivets are being used less and less. In many areas they have been replaced by welding or bonding. Compared with blind rivets, there is the disadvantage that the joint must be accessible from both sides.

This type of rivet is still widely used in aircraft construction. However, special light metal alloys and installation methods are mainly used here in order to be able to guarantee a high safety standard.

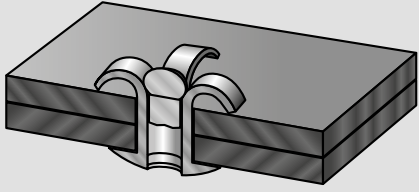
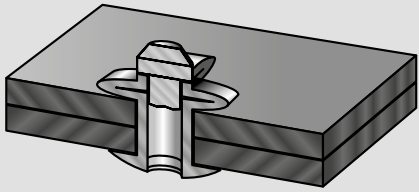
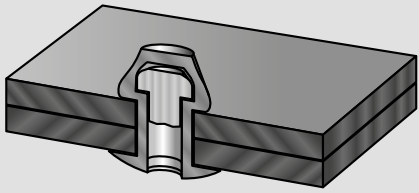
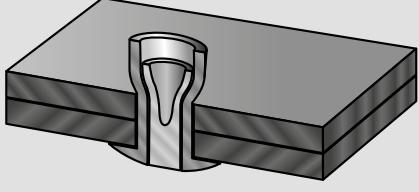
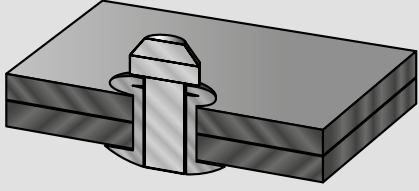
3.1. Solid rivets – Materials

Solid rivets can be made from steel, stainless steels and non-ferrous metals.

The following are the most common materials

Material type	Material designation	Material standard
Steel	C4C or C10C	EN 10363-2
Stainless steel	X3CrNiCu18-9-4	EN 10263-5
Non-ferrous metal	CuZn = CuZn37	EN 12166
Non-ferrous metal	Cu = Cu-DHP	EN 12166
Non-ferrous metal	Al = EN AW-1050A (Al99,5)	EN 1301-2

Table 11: Solid rivet materials

Unless otherwise agreed, rivets made of steel are soft annealed to 85 HV - 130 HV. Special agreements might have to be made for all other materials.





3.2. Solid rivets – Corrosion protection

As a rule, solid rivets are made without an anti-corrosion coating. Steel rivets are usually lightly oiled to provide temporary protection against corrosion.

If steel rivets are made with galvanic surface protection or other corrosion protection coatings, it must be expected that after the rivet has been installed, the corrosion resistance will be severely impaired, at least at the locking head end.

3.3. Solid rivets – Standardized variants

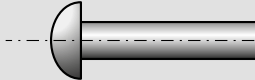
The blind rivets listed below have thus far been regulated by standards:

Designation	ISO standard	German DIN standard	Material combination	View
Button-head rivets – nominal diameters 10 mm to 36 mm	none	124	St, CuZn, Al, X3CrNiCu18-9-4	
Countersunk rivets – nominal diameters 10 mm to 36 mm	none	302	St, CuZn, Al, X3CrNiCu18-9-4	
Button-head rivets – nominal diameters 1 mm to 8 mm	none	660	St, CuZn, Al, X3CrNiCu18-9-4	
Countersunk rivets – nominal diameters 1 mm to 8 mm	none	661	St, CuZn, Al, X3CrNiCu18-9-4	



Designation	ISO standard	German DIN standard	Material combination	View
Oval countersunk rivets – nominal diameters 1.6 mm to 6 mm	none	662	St, CuZn, Al, X3CrNiCu 18-9-4	
Truss-head rivets – nominal diameters 1.4 mm to 6 mm	none	674	St, CuZn, Al, X3CrNiCu 18-9-4	
Truss-head countersunk rivets (belt rivets) – nominal diameters 3 mm to 5 mm	none	675	St, CuZn, Al, X3CrNiCu 18-9-4	

Table 12: Solid rivets regulated by standards

3.4. Solid rivets – Component preparation

The rivet hole diameter required for the respective nominal rivet diameter can be produced without cutting by means of punching or laser beam processes (or other beam processes), or by cutting in the form of drilling. When making the rivet holes, it must be ensured that the permissible rivet hole tolerances are adhered to.

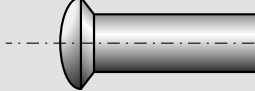
The rivet hole must be free of burrs before the rivet is installed. The contact surface of the blind rivet setting head must be free of chips and other impurities.

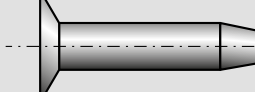
Make sure that the contact surface is level and at right angles to the rivet hole.

The rivet hole diameter can be found in the respective product standard

3.5. Solid rivets – Clamping range

The locking head can be shaped as a half round head or a countersunk head. The possible clamping range of a solid rivet varies depending on this. Refer to the product standard for the relevant details

3.6. Solid rivets – Installation

Solid rivets are normally installed in three steps:

Step	Description	Diagram
1	Drawing in the rivet	
2	Upsetting and reshaping the rivet	
3	Final shaping of the locking head	

Table 13: Installation steps for solid rivets

Solid rivets with a nominal diameter of less than 10 mm are drawn in, reshaped and finished with a hammer and a suitable riveting tool. From a nominal diameter of 10 mm, the rivets are knocked hot due to the high degree of material embrittlement that occurs during cold forming. For this, the rivets are heated to around 1000 °C immediately before installation. When the rivets are knocked hot, the locking head is usually formed with machine tools.

3.7. Solid rivets – Checking

The check of joints made with solid rivets is basically identical to that for blind rivets.

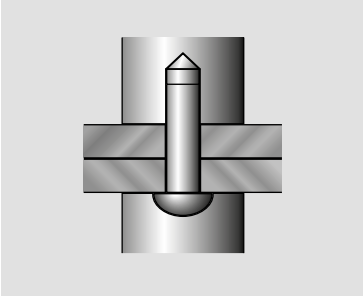
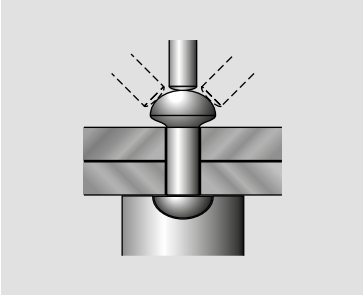
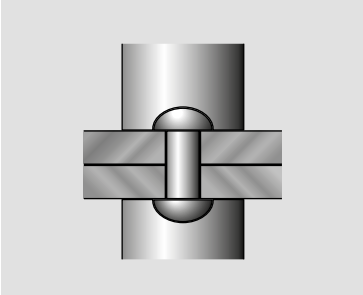
Exception: All points that deal with the topic of rivet mandrels or remaining rivet mandrels are not valid for solid rivets.

4. Functional blind rivet element, blind rivet nut

Blind rivet nuts are mechanical fasteners and primarily fulfill the function of a screw nut. However, blind rivet nuts can also be used to connect two components. Blind rivet nuts are inserted into a drill hole from one side and set with a mechanical, electrical or pneumatic setting tool. During the setting process, a defined part of the shank is formed into a locking head.

4.1. Blind rivet nuts – Materials and anti-corrosion coatings

Blind rivet nuts are made of various materials. The most frequently used materials and, if applicable, anti-corrosion coatings are listed below.

Material	Corrosion protection coating
Steel (St)	Galvanized and passivated
Stainless steel (A2 or A4)	Not necessary
Aluminum alloy (Al)	Not necessary

Table 14: Materials and corrosion protection

4.2. Blind rivet nuts – Types

Blind rivet nuts are manufactured with different setting head designs and shank shapes:

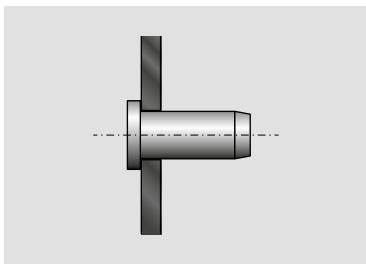
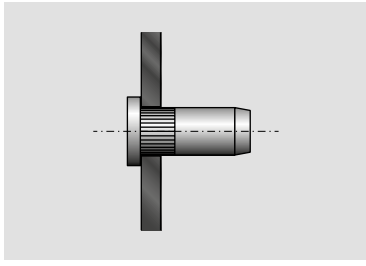
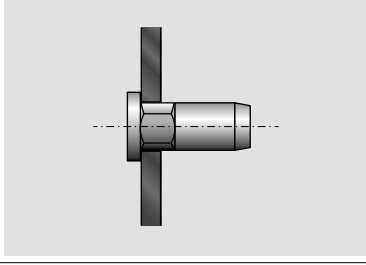
Type	Diagram
Dome head with smooth shank	
Dome head with knurled shank	
Dome head with hexagonal shank	

Type	Diagram
Countersunk head with smooth shank	
Countersunk head with knurled shank	
Small countersunk head with smooth shank	
Small countersunk head with knurled shank	

Table 15: Blind rivet nut types

4.3. Blind rivet nuts – Installation principle

Blind rivet nut installation is divided into three work steps:

Step	Description	Diagram
1	The blind rivet nut is screwed onto the threaded mandrel of the setting tool by hand.	

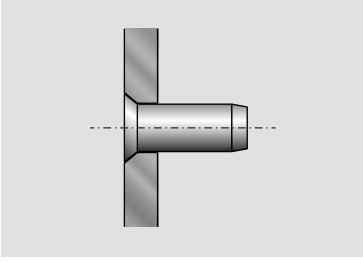
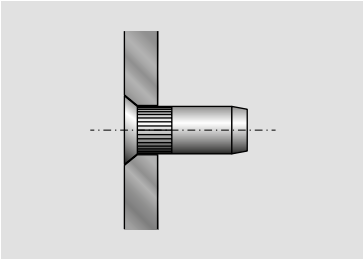
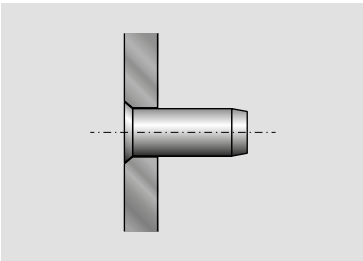
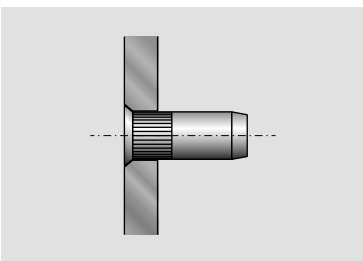
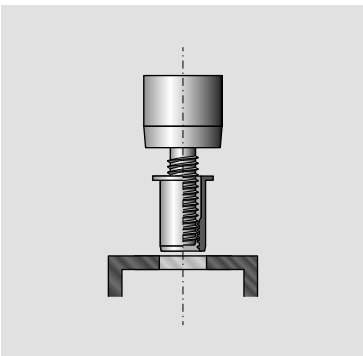
Step	Description	Diagram
2	The blind rivet nut is inserted into the rivet hole up to the setting head contact surface. By releasing the setting tool stroke (pulling in the axial direction), part of the blind rivet nut's shank is reshaped and the locking head is formed.	
3	The threaded mandrel is unscrewed from the set blind rivet nut.	

Table 16: Blind rivet nuts – Installation principle

4.4. Blind rivet nuts – Joining properties

With blind rivet nuts, a rivet joint and a nut thread can be produced in one operation. Special features of blind rivet nuts are also:

- Insertion of nut threads into thin-walled components
- Joining (riveting) of several components, which can also consist of different materials
- Damage-free joining of coated components (if drill holes were made before coating)
- The component only needs to be accessible from one side
- Joining without thermal influences, therefore minimal distortion

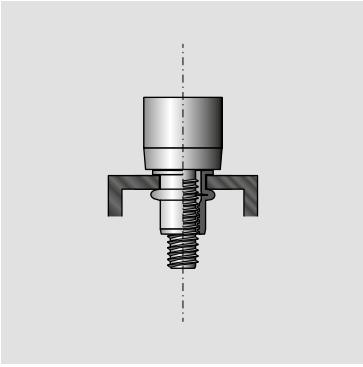
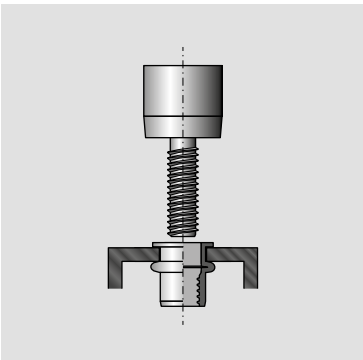
4.5. Blind rivet nuts – Mechanical properties

The mechanical properties of a blind rivet nut connection must be determined via tests on the real component. The setting head geometry, the component thickness, the shank shape and the material of the blind rivet nut and component have a major influence on the tensile strength, the shear strength and the maximum possible tightening torque of such a joint.

4.6. Blind rivet nuts – Clamping range

When selecting a blind rivet for joining components, it is essential to ensure compliance with the clamping range defined by the manufacturer. The clamping range of a blind rivet is defined by the difference between the minimum component thickness being worked with ($t_{tot, min}$) and the maximum component thickness being worked with ($t_{tot, max}$).

It should also be ensured that the minimum and maximum clamping range is not fully used. In such cases, tolerances and influences often lead to problems and unsatisfactory results.

4.7. Blind rivet nuts – Component preparation

Careful component preparation is necessary in order to ensure the functional reliability of a blind rivet nut joint. Incorrect or improper preparation leads to installation problems and affects the strength of the joint.

Attention must be paid to the following points:

- Drill hole diameter and drill hole tolerances must be designed and adhered to in accordance with the specifications of the blind rivet nut manufacturer.
- The clamping length specified by the blind rivet nut manufacturer must be adhered to.
- The drill hole for the blind rivet nut must be burr-free at the setting head end. A burr should be removed as much as possible at the locking head end.
- The countersunk depth for blind rivet nuts with countersunk heads must be designed so that the countersunk head protrudes at least 0.1 mm above the component surface after setting. The component being joined rests on the countersunk head as a result. This is necessary in order to be able to apply the maximum tightening torque. Certain installation situations, e.g. outdoors to avoid corrosion-promoting gaps, might make other specifications necessary.
- Rivet holes for blind rivet nuts with a small countersunk head do not have to be countersunk.
- When using blind rivet nuts with a smooth shank, care must be taken to ensure that the setting head contact surface and drill hole are oil-free and grease-free.

4.8. Blind rivet nuts – Installation instructions

- The setting head of blind rivet nuts must project by minimum 0.1 mm after the setting operation (exception: specific design specifications).
- Setting tools must be adjusted so that all threads of the blind rivet nuts are detected by the threaded mandrel of the installation tool.
- The setting stroke required for the perfect setting of a blind rivet nut depends on the fastening element and the component thickness. Tests for setting the correct setting stroke are necessary particularly in the case of electric or pneumatic setting tools.
- The locking head must rest completely on the component after the setting operation.
- Setting of the blind rivet nut must be done at right angles to the component surface.
- It must be possible to unscrew the threaded mandrel out of the blind rivet nut after the setting operation without having to increase the amount of force used.
- The component being fastened must rest on the setting head of the blind rivet nut, otherwise there is a risk that the joining element will rotate when the tightening torque is applied.
- The maximum possible tightening torque must be determined via tests. A sufficiently large difference between the tightening torque and the overtightening torque must be ensured.

4.9. Blind rivet nuts – Installation tools

See below for an overview of common installation tools:

Installation tool	Image	Note
Manual blind rivet nut pliers		<ul style="list-style-type: none"> • Easy to use • Low cost • For blind rivet nuts up to max. M6 (with restrictions up to M8)
Lever-operated blind rivet nut tool		<ul style="list-style-type: none"> • Easy to use • For blind rivet nuts made of all materials up to M10 (with restrictions up to M12)
Cordless blind rivet nut tool		<ul style="list-style-type: none"> • Easy to use • For blind rivet nuts made of aluminum up to M10, made of steel up to M8, made of stainless steel up to M6 • Suitable for series blind rivet nut installation • Can be used flexibly and independently of a stationary energy supply
Pneumatic blind rivet nut tool		<ul style="list-style-type: none"> • Easy to use • For blind rivet nuts made of aluminum and steel up to M12, made of stainless steel up to M10 • Suitable for series blind rivet nut installation • Continuous compressed air supply required
Blind rivet nut attachment for cordless or corded power tools		<ul style="list-style-type: none"> • Easy to use • Low cost • For blind rivet nuts made of all materials up to M8 • Suitable for series blind rivet nut installation • Can be used flexibly and independently of a stationary energy supply

Table 17: Blind rivet nuts installation tools

4.10. Blind rivet nuts – Repair possibilities

Blind rivet studs with a round shank can be drilled out. The nominal drill diameter must be identical to the outside diameter of the blind rivet shank. This means that a similar blind rivet nut can be set again after drilling out.

Blind rivet nuts with a hexagonal shank can be drilled out. The nominal diameter of the drill should correspond to the corner size of the used blind rivet nut with hexagonal shank. This allows a blind rivet nut with a round shank to be set after drilling out. If necessary, the diameter of the hole must be adjusted before setting onto the new round shank blind rivet nut type.

4.11. Blind rivet nuts – Quality assurance

Non-destructive and destructive methods can be used to check the joint quality.

Non-destructive test

The following points can be checked non-destructively by means of visual inspection and function testing.

- Flat setting head contact
- Joining gaps prevented
- The possibility of screwing in the connecting elements (stud) and checking the load capacity (max. tightening torque as specified by the designer)

It is essential for the user to ensure that the following requirements are met in order to obtain a perfect result:

- Adherence to the correct drill hole tolerance
- Adherence to the permissible clamping range

If all of the points mentioned are adhered to, a general statement can be made about the joint.

Destructive test

The design of the joining element can be checked by means of a macro-section. To do this however, it is necessary to identically simulate the real installation state or even to carry out the test on original components. Particular attention should be paid to the following points during this test:

- The area between the blind rivet nut setting head and the component contact surface at the setting head end should be free of gaps
- As symmetrical as possible shaping of the locking head
- Gap-free area between the formed locking head and the component contact surface
- Blind rivet nut should be straight inside the drill hole
- Drill hole should be filled in

4.12. Blind rivet nuts – Special form

The neoprene rivet nut is a special form of rivet nut. This type enables detachable, electrically-insulating rivet joints with vibration-reducing and noise-reducing functions to be made for fastening metal and plastic connections.

The following features are characteristic of neoprene rivet nuts.

Version:

Dome head

Material:

Neoprene rivet nuts (EPDM, Shore hardness 60) with brass insert.

Advantages:

Processing in blind holes. Dual function as thread carrier or fastener. Airtight and moisture-proof joint. Ideal for various materials.

Possible installation temperatures:

-30°C to +80°C.

Areas of application:

Electronics construction, vehicle construction, trailer construction, sign construction, steel construction, plant construction, air conditioning and refrigeration technology, agricultural technology

Installation sequence:

Step 1	Step 2	Step 3	Step 4
Drill the hole, deburr it and insert the neoprene nut.	To form the locking head, place a washer or the component onto the setting head.	Screw in the stud	Tighten the screw (determine the over-tightening torque via tests). To dismantle, loosen the stud and pull out the rivet nut if necessary.
			

Table 18: Neoprene nut installation sequence

5. Functional blind rivet element, blind rivet studs

Blind rivet studs are mechanical fasteners and primarily fulfill the function of a screw bolt. However, blind rivet studs can also be used to connect two components. Blind rivet studs are inserted into a drill hole from one side and set with a mechanical setting tool. During the setting process, a defined part of the shank is formed into a locking head.

5.1. Blind rivet studs – Materials and anti-corrosion coatings

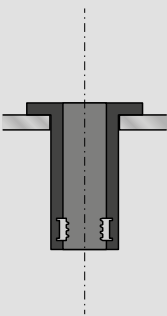
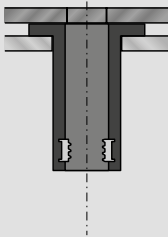
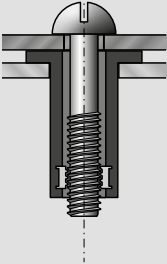
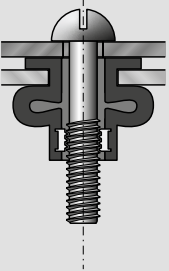
Blind rivet studs are made of steel as standard, and are zinc plated and transparent or blue passivated.

5.2. Blind rivet studs – Types

Blind rivet studs are usually manufactured with two different setting head designs:

Type	Diagram
Dome head with smooth shank	
Countersunk head with smooth shank	

Table 19: Blind rivet stud types

5.3. Blind rivet studs – Installation principle

Blind rivet stud installation is divided into three work steps:

Step	Description	Diagram
1	The blind rivet stud is screwed into the mouthpiece of the setting tool by hand.	
2	The blind rivet stud is inserted into the rivet hole up to the setting head contact surface. By releasing the setting tool stroke (pulling in the axial direction), part of the blind rivet stud's shank is reshaped and the locking head is formed.	
3	The mouthpiece is unscrewed from the set blind rivet stud.	

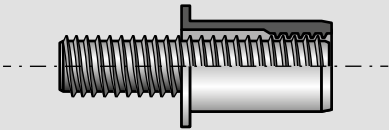
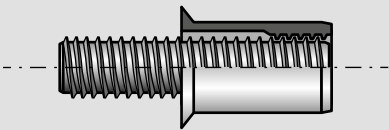
Table 20: Blind rivet stud installation principle

5.4. Blind rivet studs – Joining properties

With blind rivet studs, a rivet joint can be produced with a stud bolt in one operation. Special features of blind rivet studs are also:

- Insertion of stud bolt into thin-walled components.
- Joining (riveting) of several components, which can also consist of different materials.
- Damage-free joining of coated components (if drill holes were made before coating).
- The component only needs to be accessible from one side.
- Joining without thermal influences, therefore minimal distortion.

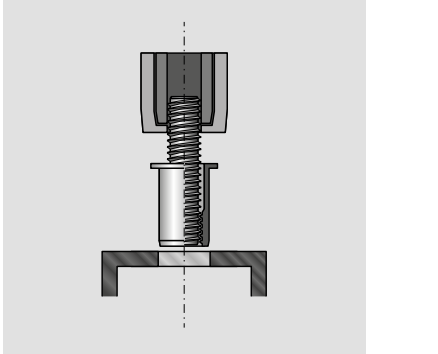
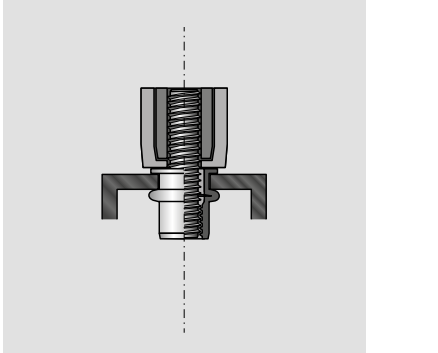
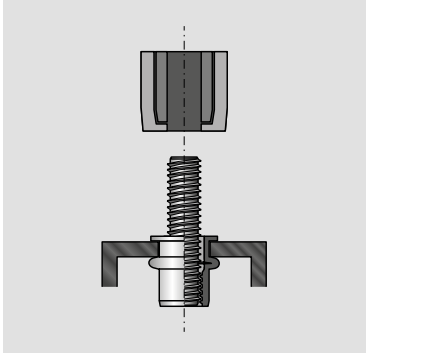
5.5. Blind rivet studs – Mechanical properties

The mechanical properties of a blind rivet stud must be determined via tests on the real component. The setting head geometry, the component thickness, the shank shape and the material of the blind rivet stud and components have a major influence on the tensile strength, the shear strength and the maximum possible tightening torque of such a joint.

5.6. Blind rivet studs – Clamping range

When selecting a blind rivet stud for joining components, it is essential to ensure compliance with the clamping range defined by the manufacturer. The clamping range of a blind rivet stud is defined by the difference between the minimum component thickness being worked with ($t_{\text{tot, min}}$) and the maximum component thickness being worked with ($t_{\text{tot, max}}$).

It should also be ensured that the minimum and maximum clamping range is not fully used. In such cases, tolerances and influences often lead to problems and unsatisfactory results.

5.7. Blind rivet studs – Component preparation

Careful component preparation is necessary in order to ensure the functional reliability of a blind rivet stud joint. Incorrect or improper preparation leads to installation problems and affects the strength of the joint.

Attention must be paid to the following points:

- Drill hole diameter and drill hole tolerances must be designed and adhered to in accordance with the specifications of the blind rivet stud manufacturer.
- The clamping length specified by the blind rivet stud manufacturer must be adhered to.
- The drill hole for the blind rivet stud must be burr-free at the setting head end. A burr should be removed as much as possible at the locking head end.
- The countersunk depth for blind rivet studs with countersunk heads must be designed so that the countersunk head protrudes at least 0.1 mm above the component surface after setting. The component being joined rests on the countersunk head as a result. This is necessary in order to be able to apply the maximum tightening torque. Certain installation situations, e.g. outdoors to avoid corrosion-promoting gaps, might make other specifications necessary.
- Ensure that the setting head contact surface and drill hole are oil-free and grease-free.

5.8. Blind rivet studs – Installation instructions

- The setting head of blind rivet studs must project by at least 0.1 mm after the setting operation (exception: specific design specifications).
- Setting tools must be adjusted so that all threads of the blind rivet stud are detected by the mouthpiece of the installation tool. A screw-in depth of at least $1 \times d$ (nominal thread diameter) must be ensured in the case of long stud bolts.
- The setting stroke required for the perfect setting of a blind rivet stud depends on the fastening element and the component thickness. Tests for setting the correct setting stroke are necessary particularly in the case of electric or pneumatic setting tools.
- The locking head must rest completely on the component after the setting operation.
- The blind rivet stud must be set at right angles to the component surface.
- It must be possible to unscrew the mouthpiece out of the blind rivet stud after the setting operation without having to increase the amount of force used.
- The component being fastened must rest on the setting head of the blind rivet stud, otherwise there is a risk that the joining element will rotate when the tightening torque is applied.
- The maximum possible tightening torque must be determined via tests. A sufficiently large difference between the tightening torque and the overtightening torque must be ensured.

5.9. Blind rivet studs – Installation tools

See below for an overview of common installation tools:

Installation tool	Image	Note
Manual blind rivet screwing tool		<ul style="list-style-type: none"> • Easy to use • Low-cost
Lever-action blind rivet screwing tool		<ul style="list-style-type: none"> • Easy to use • Not much force required

Table 21: Blind rivet stud installation tools

5.10. Blind rivet studs – Repair possibilities

Blind rivet studs with a round shank can be drilled out. The nominal drill diameter must be identical to the outside diameter of the blind rivet shank. This means that a similar blind rivet stud can be set again after drilling out.

5.11. Blind rivet studs – Quality assurance

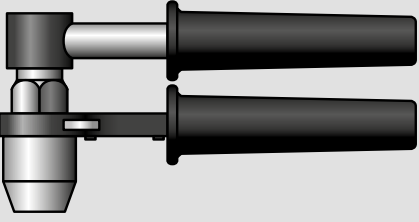
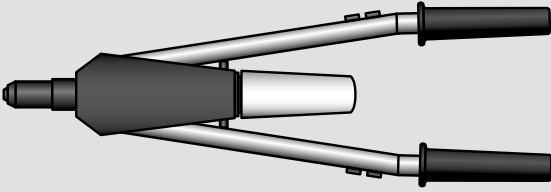
Non-destructive and destructive methods can be used to check the joint quality.

Non-destructive test

The following points can be checked non-destructively by means of visual inspection and function testing.

- Flat setting head contact
- Joining gaps prevented
- The threaded bolt can be overtightened and the load capacity checked (max. tightening torque as specified by the designer)

It is essential for the user to ensure that the following requirements are met in order to obtain a perfect result:

- Adherence to the correct drill hole tolerance
- Adherence to the permissible clamping range

If all of the points mentioned are adhered to, a general statement can be made about the joint.

Destructive test

The design of the joining element can be checked by means of a macro-section. To do this however, it is necessary to identically simulate the real installation state or even to carry out the test on original components. Particular attention should be paid to the following points during this test:

- The area between the blind rivet stud setting head and the component contact surface at the setting head end should be free of gaps
- As symmetrical as possible shaping of the locking head
- Gap-free area between the formed locking head and the component contact surface
- Blind rivet stud should be straight inside the drill hole
- Drill hole should be filled in

6. Other riveting elements

Various other rivets have been developed for special purposes. Below is an overview of various rivet shapes:

Designation	Standard	Description	Diagram
Semi-tubular rivet with dome head	DIN 6791	The semi-tubular rivet belongs to the group of tenon rivets. The end of the drill hole is widened and the locking head forms.	
Semi-tubular rivet with countersunk head	DIN 6792	The semi-tubular rivet belongs to the group of tenon rivets. The end of the drill hole is widened and the locking head forms.	
Two-part hollow rivet	DIN 7331	Hollow rivets are formed from sheet metal. There are two types: Type A with dome head open at one end and Type B with dome head open at both ends. Due to their low resilience, two-part hollow rivets are mainly used for decorative purposes in leather and textiles.	
			
One-part hollow rivet	DIN 7339	Hollow rivets as defined in DIN 7339 are cylindrical sleeves drawn from strip, with a flat edge at one end. The other end is flanged with a special tool (riveting pin). Hollow rivets are also used for riveting fabrics and leather or other non-metallic materials.	
Hollow rivet	DIN 7340	Hollow rivets as defined in DIN 7340 are cylindrical sleeves drawn from tube, with a flat (Type A) or curved (Type B) collar at one end. The other end is flanged with a special tool (riveting pin). Hollow rivets are also used for riveting fabrics and leather or other non-metallic materials.	
			
Split rivet (hammer Rivet)	Factory standard	A split rivet is a hollow rivet slotted at the shank end. Knocking in the pin spreads the shank end. This type is made both from steel and from plastic in many manufacturer-specific variants.	
U-hammer drive screw	ANSI B18.6.4	The U-hammer drive screw is a modification of the split rivet. The shank has a helical surface and an insertion pin. The connecting element is only driven into one hole and sticks inside it due to the surface geometry.	
Screw rivet	Factory standard	The screw rivet is a special solution for high-strength rivet joints. The setting head is held with a special installation tool and at the same time the screw, which replaces the rivet mandrel in this type, is screwed in. This forms the locking head. Advantages of this type are simple and quick installation and no waste in the form of a rivet mandrel.	

Table 22: Other rivet variants

6.1. Fault causes and effects on riveted joints

Various faults can arise when installing blind rivets. The following are some of the most common effects and the causes of the faults:

Consequences	Cause of defect
<ul style="list-style-type: none"> • The remaining rivet mandrel protrudes from the drawn rivet sleeve after installation. • Joint has little or no tensile or shear strength. 	Selected clamping range is too large
<ul style="list-style-type: none"> • Insufficient tensile or shear strength. • Rivet mandrel breaks off at the predetermined breaking point, but protrudes from the sleeve. 	Clamping range too small
<ul style="list-style-type: none"> • No fixed rivet joint for the riveted components, drill hole is not completely filled after setting. 	Drill hole too large
<ul style="list-style-type: none"> • Blind rivet sleeve cannot be inserted into the drill hole. 	Drill hole too small
<ul style="list-style-type: none"> • Rivet mandrel has a lot of play in the mouthpiece. • Rivet cannot be drawn with the installation tool. 	Wrong, worn or dirty mouthpiece

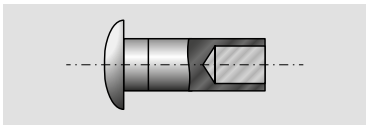
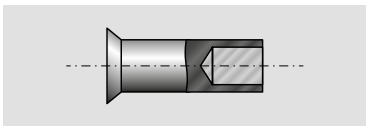
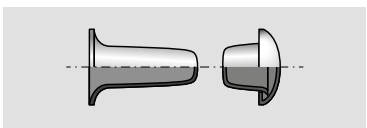
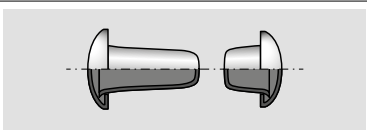
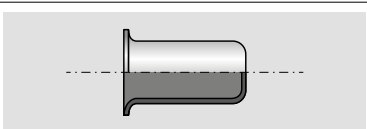
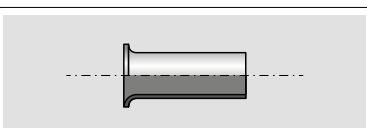
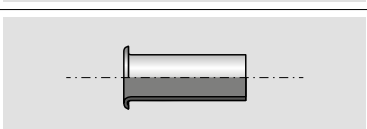
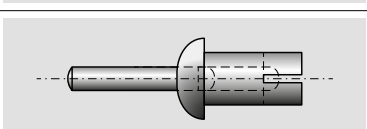
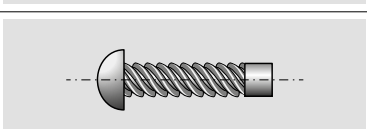
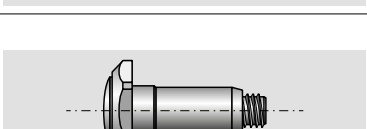
Table 23: Causes of faulty rivet joints

CONNECT

VOLUME II

Riveting Technology

Adolf Würth GmbH & Co. KG
74650 Künzelsau, Germany
Tel +49 7940 15 - 0
Fax +49 (0)7940 15-1000
info@wuerth.de
www.wuerth.de

© by Adolf Würth GmbH & Co. KG
Printed in Germany
All rights reserved.
Responsible for content:
PCV dept./Frank Puchler
Editorial staff:
GMV dept./Joachim Hellmann

Reprint only with permission
SBRO040859-GMV-SF-SCH-7,5'-07/21

We reserve the right to make any changes we deem necessary to improve the quality of the product, even without prior announcement or notification.
Illustrations may be sample illustrations which could differ in appearance from the actual goods delivered. Errors excepted. We do not assume liability for printing errors.
Our general terms and conditions apply.

